

Silicon Carbide (SiC) Module – EliteSiC Power Module for Traction Inverter, Single-Side Cooling, 2.6 mohm, 1200 V, Half-Bridge, 90° Power Tabs

NVVR26A120M1WSS

Product Description

The NVVR26A120M1WSS is part of the EliteSiC power module for traction inverter, a revolutionary high mobility compound semiconductor product family that offers increased performance, better efficiency, and higher power density in similar and highly compatible packaging solutions. The module integrates 1200 V SiC MOSFET in a half-bridge configuration. To enhance reliability and thermal performance, sintering technology is applied for die attach. The module is designed to meet the AQC324 standard.

Features

- Ultra Low $R_{DS(on)}$
- Aluminum Nitride Isolator
- Ultra-low Stray Inductance ~ 7.1 nH
- $T_{vj,Max} = 175^{\circ}C$ for Continuous Operation
- Automotive Grade SiC MOSFET Chip Technologies
- Sintered Die Technology for High Reliability Performance
- Automotive Module AQC324 Compliant
- PPAP Capable

Applications

- Automotive EV/HEV– Traction Inverter

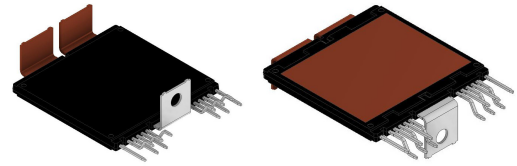

AHPM15-CDI MODULE
CASE MODHN

MARKING DIAGRAM

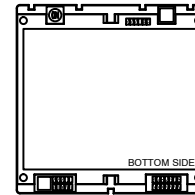

ZZZ ATYWW	K2R261S NNNNNNN
--------------	--------------------

ZZZ = Assembly Lot Code
 K2R261S = Marking Value
 AT = Assembly & Test Location
 Y = Year
 WW = Work Week
 NNNN = Serial Number

PIN CONFIGURATION

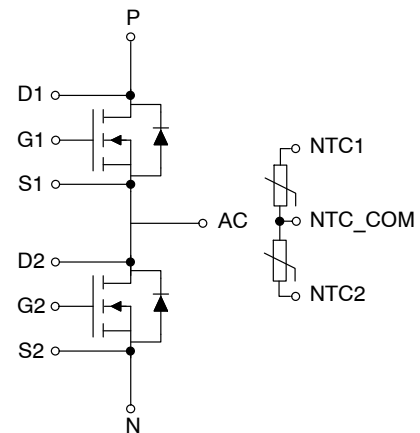

ORDERING INFORMATION

Device	Package	Shipping
NVVR26A120M1WSS	A1HPM	Tube

NVVR26A120M1WSS

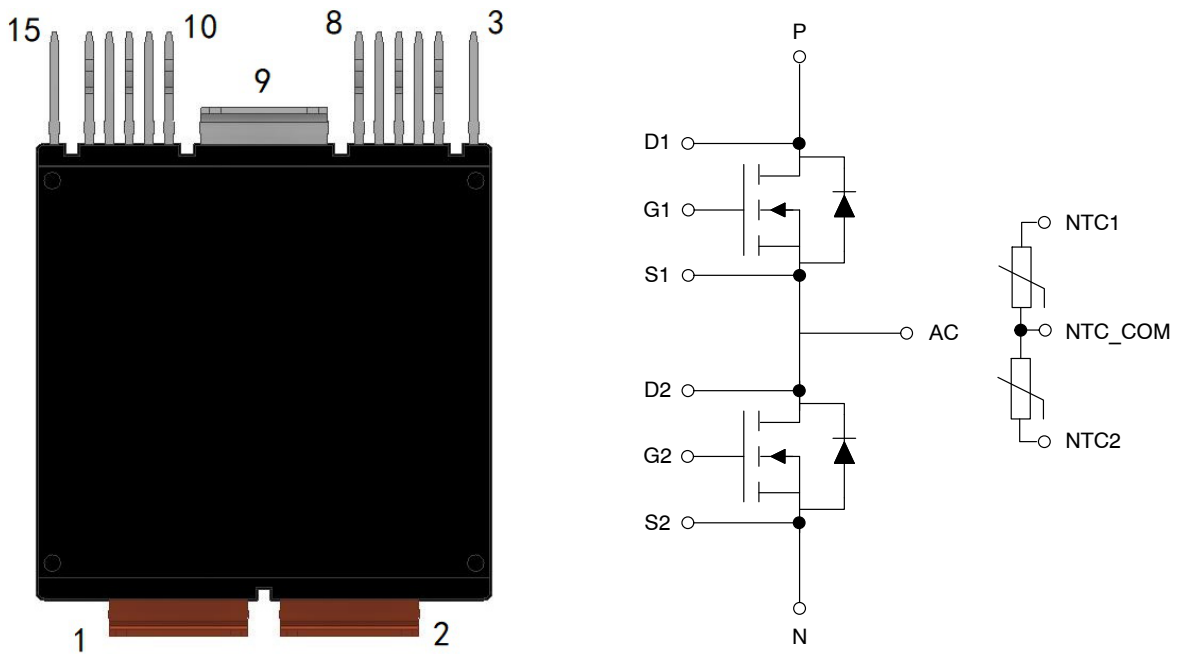

Figure 1. Pin Description

PIN FUNCTION DESCRIPTIONS

Pin No.	Pin Name	Pin Functional Description
1	N	Negative Power Terminal
2	P	Positive Power Terminal
3	D1	High Side MOSFET (Q1) Drain Sense
4	N/C	No Connection
5	S1	High Side MOSFET (Q1) Source
6	G1	High Side MOSFET (Q1) Gate
7	N/C	No Connection
8	N/C	No Connection
9	AC	Phase Output
10	NTC1	NTC 1
11	S2	Low Side MOSFET (Q2) Source
12	G2	Low Side MOSFET (Q2) Gate
13	NTC2	NTC 2
14	NTC_COM	NTC common
15	D2	Low Side MOSFET (Q2) Drain Sense

Materials

DBC Substrate: AlN isolated substrate, basic isolation, and copper on both sides

Lead frame: Pin 1,2 copper without plating. Pin 3 to 15 copper, with tin electro-plating.

Flammability Information

All materials present in the power module meet UL flammability rating class 94V-0

NVVR26A120M1WSS

MODULE CHARACTERISTICS ($T_{vj} = 25^{\circ}\text{C}$, Unless Otherwise Specified)

Symbol	Parameter	Rating	Unit
T_{vj}	Operating Junction Temperature	-40 to 175	$^{\circ}\text{C}$
T_{STG}	Storage Temperature Range	-40 to 125	$^{\circ}\text{C}$
V_{ISO}	Isolation Voltage (AC, 50 Hz, 5 s)	4200	V
L_{SDS}	Stray Inductance	7.1	nH
R_{DD+SS}	Module Lead Resistance, Terminal to Chip	0.3	$\text{m}\Omega$
G	Module Weight	48	g
CTI	Comparative Tracking Index	>600	-
Creepage	Minimum: Terminal to Terminal	5.0	mm
Clearance	Minimum: (Note 1) Terminal to Terminal	3.2	mm
M	M5 DIN 439B Screws for Module Terminals, Max. Torque	2.2	Nm

1. Verified by design/characterization, not tested.

ABSOLUTE MAXIMUM RATINGS ($T_{vj} = 25^{\circ}\text{C}$, Unless Otherwise Specified)

Symbol	Parameter	Rating	Unit
V_{DS}	Drain-Source Voltage	1200	V
V_{GS}	Gate-Source Voltage	+25/-10	V
I_{DS}	Continuous DC Current, $V_{GS} = 20\text{ V}$, $T_{vj} = 175^{\circ}\text{C}$, $T_F = 65^{\circ}\text{C}$ @ 10LPM, using Ref. Heatsink (Note 2)	400	A
$I_{DS,pulsed}$	Pulsed Drain-Source Current, $V_{GS} = 20\text{ V}$, limited by $T_{vj,Max}$	800	A
$I_{SD,BD}$	DC Current in Body Diode, $V_{GS} = -5\text{ V}$, $T_{vj} = 175^{\circ}\text{C}$, $T_F = 65^{\circ}\text{C}$ @ 10LPM, using Ref. Heatsink (Note 2)	270	A
$I_{SD,pulsed}$	Pulsed Body Diode Current, $V_{GS} = -5\text{ V}$, limited by $T_{vj,Max}$	800	A
P_{tot}	Total Power Dissipation $T_{vj,Max} = 175^{\circ}\text{C}$, $T_F = 65^{\circ}\text{C}$, Ref. Heatsink (typ)	1000	W

Stresses exceeding those listed in the Maximum Ratings table may damage the device. If any of these limits are exceeded, device functionality should not be assumed, damage may occur and reliability may be affected.

2. Verified by design / not by test.

NVVR26A120M1WSS

MOSFET CHARACTERISTICS ($T_{vj} = 25^{\circ}\text{C}$, Unless Otherwise Specified)

Parameter		Conditions		Min	Typ	Max	Unit
$R_{DS(ON)}$	Drain-to-Source On Resistance (Terminal)	$V_{GS} = 20\text{V}$, $I_D = 400\text{A}$	$T_{vj} = 25^{\circ}\text{C}$ $T_{vj} = 175^{\circ}\text{C}$	-	2.6 4.6	-	m Ω
$V_{GS(TH)}$	Gate Threshold Voltage	$V_{GS} = V_{DS}$, $I_D = 150\text{mA}$		2.1	3.2	-	V
g_{fs}	Forward Transconductance	$V_{DS} = 10\text{V}$, $I_D = 400\text{A}$		-	170	-	S
Q_G	Total Gate Charge	$V_{GS} = -5/+20\text{V}$, $V_{DS} = 800\text{V}$, $I_D = 400\text{A}$		-	1.75	-	μC
$R_{g,int}$	Internal Gate Resistance			-	2.1	-	Ω
C_{iss}	Input Capacitance	$V_{DS} = 800\text{V}$, $V_{GS} = 0\text{V}$, $f = 100\text{kHz}$		-	31.7	-	nF
C_{oss}	Output Capacitance			-	2.2	-	nF
C_{rss}	Reverse Transfer Capacitance			-	0.22	-	nF
I_{DSS}	Zero Gate Voltage Drain Current	$V_{GS} = 0\text{V}$, $V_{DS} = 1200\text{V}$	$T_{vj} = 25^{\circ}\text{C}$ $T_{vj} = 175^{\circ}\text{C}$	-	- 13.1	250 -	μA
I_{GSS}	Gate-Source Leakage Current	$V_{GS} = 20/-5\text{V}$, $V_{DS} = 0\text{V}$				± 700	nA
$T_{d,on}$	Turn On Delay, Inductive Load	$I_{DS} = 400\text{A}$, $V_{DS} = 800\text{V}$, $V_{GS} = +20/-5\text{V}$, $R_{g,on} = 3\Omega$	$T_{vj} = 25^{\circ}\text{C}$ $T_{vj} = 175^{\circ}\text{C}$	-	125 115	-	ns
T_r	Rise Time, Inductive Load	$I_{DS} = 400\text{A}$, $V_{DS} = 800\text{V}$, $V_{GS} = +20/-5\text{V}$, $R_{g,on} = 3\Omega$	$T_{vj} = 25^{\circ}\text{C}$ $T_{vj} = 175^{\circ}\text{C}$	-	59 54	-	ns
$T_{d,off}$	Turn Off Delay, Inductive Load	$I_{DS} = 400\text{A}$, $V_{DS} = 800\text{V}$, $V_{GS} = +20/-5\text{V}$, $R_{g,off} = 1\Omega$	$T_{vj} = 25^{\circ}\text{C}$, $T_{vj} = 175^{\circ}\text{C}$	-	220 228	-	ns
T_f	Fall Time, Inductive Load	$I_{DS} = 400\text{A}$, $V_{DS} = 800\text{V}$, $V_{GS} = +20/-5\text{V}$, $R_{g,off} = 1\Omega$	$T_{vj} = 25^{\circ}\text{C}$ $T_{vj} = 175^{\circ}\text{C}$	-	51 61	-	ns
E_{ON}	Turn-On Switching Loss (including diode reverse recovery loss)	$I_{DS} = 400\text{A}$, $V_{DS} = 800\text{V}$, $V_{GS} = +20/-5\text{V}$, $L_s = 17\text{nH}$, $R_{g,on} = 3\Omega$	$di/dt = 8.4\text{A/ns}$, $T_{vj} = 25^{\circ}\text{C}$ $di/dt = 9.7\text{A/ns}$, $T_{vj} = 175^{\circ}\text{C}$	-	26 28	-	mJ
E_{OFF}	Turn-Off Switching Loss	$I_{DS} = 400\text{A}$, $V_{DS} = 800\text{V}$, $V_{GS} = +20/-5\text{V}$, $L_s = 17\text{nH}$, $R_{g,off} = 1\Omega$	$dv/dt = 19.8\text{V/ns}$, $T_{vj} = 25^{\circ}\text{C}$ $dv/dt = 16.8\text{V/ns}$, $T_{vj} = 175^{\circ}\text{C}$	-	14 17	-	mJ
E_{sc}	Short Circuit Energy Withstand	$V_{GS} = 20\text{V}$, $V_{DS} = 800\text{V}$	$T_{vj} = 25^{\circ}\text{C}$ $T_{vj} = 175^{\circ}\text{C}$	-	12 11	-	J

NVVR26A120M1WSS

BODY DIODE CHARACTERISTICS ($T_{vj} = 25^{\circ}\text{C}$, Unless Otherwise Specified)

Parameters		Conditions		Min	Typ	Max	Unit
V_{SD}	Diode Forward Voltage (Terminal)	$V_{GS} = -5\text{ V}$, $I_{SD} = 400\text{ A}$ $T_{vj} = 25^{\circ}\text{C}$ $T_{vj} = 175^{\circ}\text{C}$		-	3.8 3.3	-	V
E_{rr}	Reverse Recovery Energy	$I_{SD} = 400\text{ A}$, $V_R = 800\text{ V}$, $V_{GS} = -5\text{ V}$, $L_s = 17\text{ nH}$, $R_{g,on} = 3\ \Omega$	$di/dt = 8.4\text{ A/ns}$, $T_{vj} = 25^{\circ}\text{C}$ $di/dt = 9.7\text{ A/ns}$, $T_{vj} = 175^{\circ}\text{C}$	-	0.4 2.1	-	mJ
Q_{RR}	Recovered Charge	$I_{SD} = 400\text{ A}$, $V_R = 800\text{ V}$, $V_{GS} = -5\text{ V}$, $R_{g,on} = 3\ \Omega$	$T_{vj} = 25^{\circ}\text{C}$ $T_{vj} = 175^{\circ}\text{C}$	-	2.3 8.6	-	μC
I_{RR}	Peak Reverse Recovery Current	$I_{SD} = 400\text{ A}$, $V_R = 800\text{ V}$, $V_{GS} = -5\text{ V}$, $R_{g,on} = 3\ \Omega$	$T_{vj} = 25^{\circ}\text{C}$ $T_{vj} = 175^{\circ}\text{C}$	-	527 650	-	A

NTC SENSOR CHARACTERISTICS ($T_{vj} = 25^{\circ}\text{C}$, Unless Otherwise Specified)

Parameters		Conditions	Min	Typ	Max	Unit
R25	Rated Resistance	$T_c = 25^{\circ}\text{C}$	-	10	-	$\text{k}\Omega$
$\Delta R/R$	Deviation of R100	$T_c = 100^{\circ}\text{C}$, $R_{100} = 877\ \Omega$	-3	-	+3	%
P25	Power Dissipation	$T_c = 25^{\circ}\text{C}$	-	-	125	mW
B25/85	B-Value	$R = R_{25} \exp [B_{25/85} (1/T - 1/298)]$	-1%	3610	+1%	K

THERMAL CHARACTERISTICS

Symbol	Parameter	Test Conditions	Min	Typ	Max	Unit
$R_{th,J-C}$	FET Junction to Case		-	0.025	0.028	$^{\circ}\text{C/W}$
$R_{th,J-F}$	FET Junction to Fluid	R_{th} , Junction to Fluid, 10 L/min, 65°C , 50/50 EGW, Ref. Heatsink	-	0.11	-	$^{\circ}\text{C/W}$

TYPICAL CHARACTERISTICS

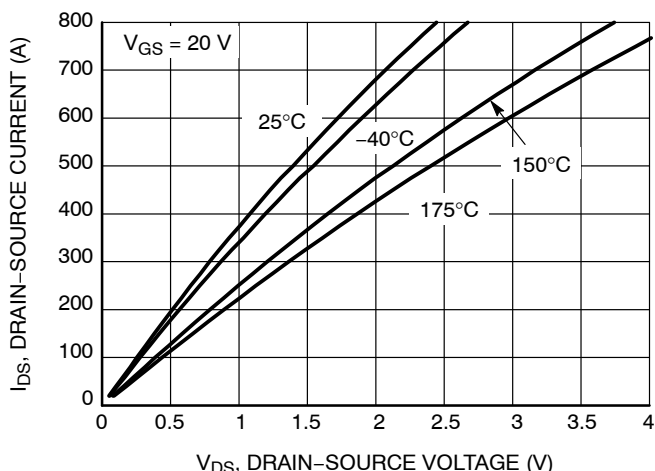

Figure 2. Output Characteristics

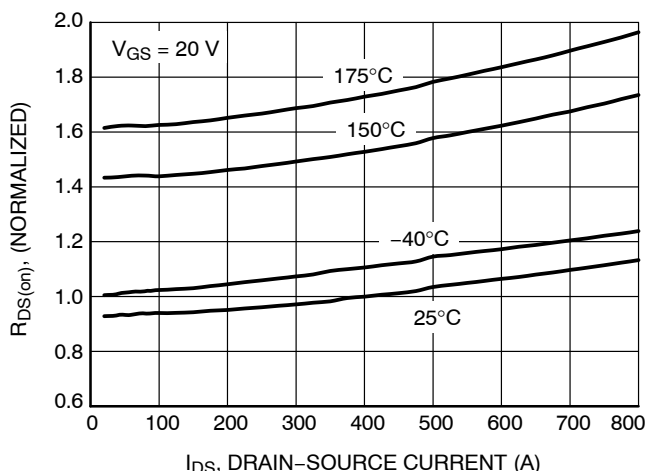

Figure 3. Normalized On-state Resistance vs. Drain Current

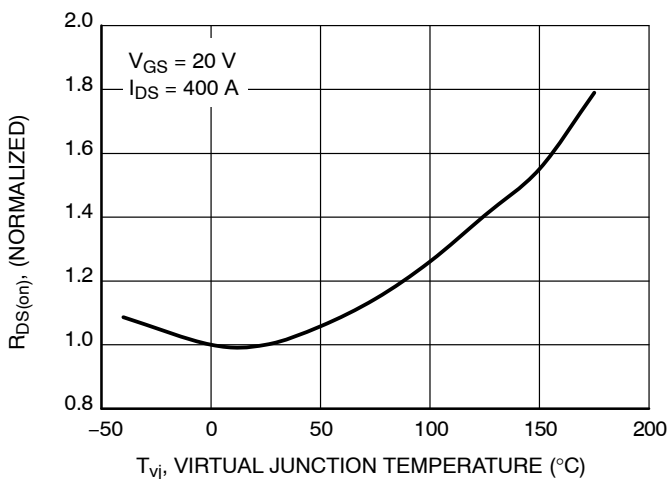

Figure 4. Normalized On-state Resistance vs. Temperature

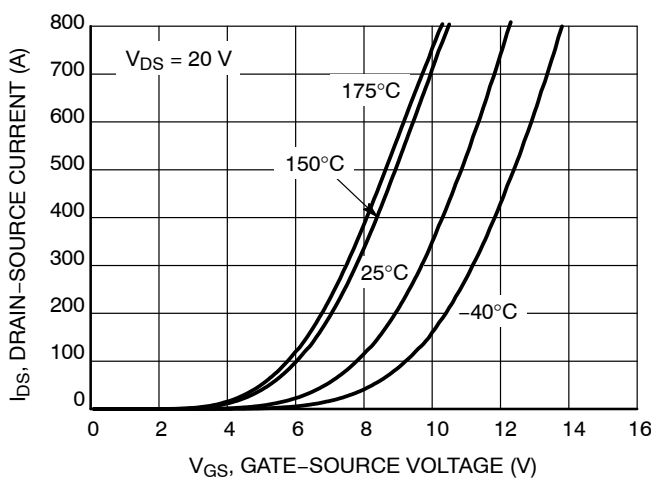

Figure 5. Transfer Characteristic

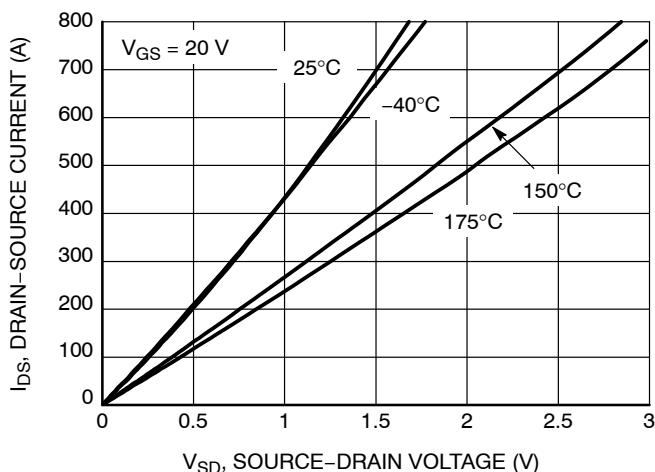

Figure 6. 3rd Quadrant Characteristic at VGS = 20 V

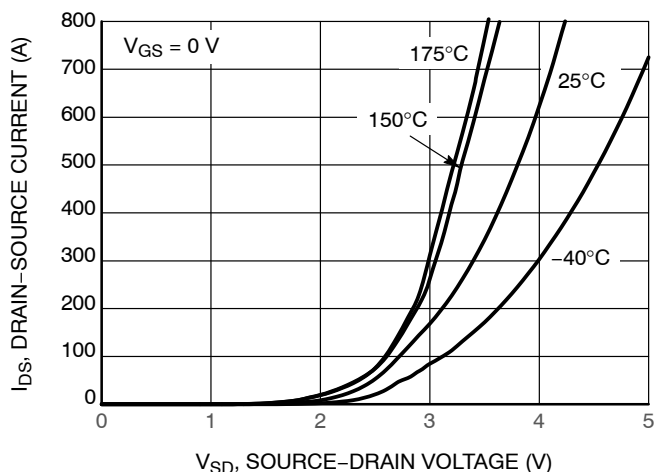

Figure 7. 3rd Quadrant Characteristic at VGS = 0 V

TYPICAL CHARACTERISTICS

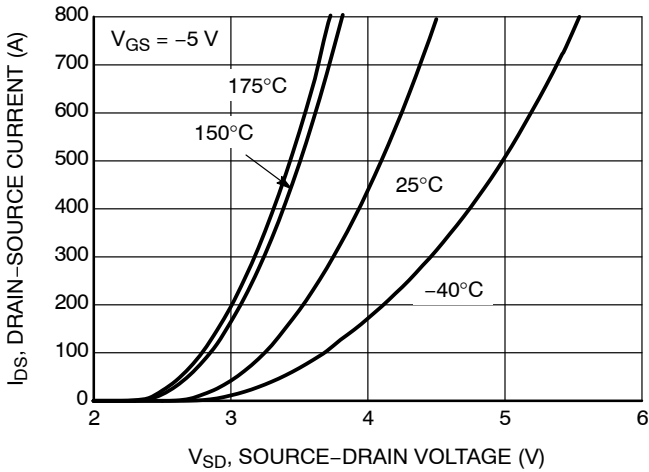

Figure 8. 3rd Quadrant Characteristic at $V_{GS} = -5 V$

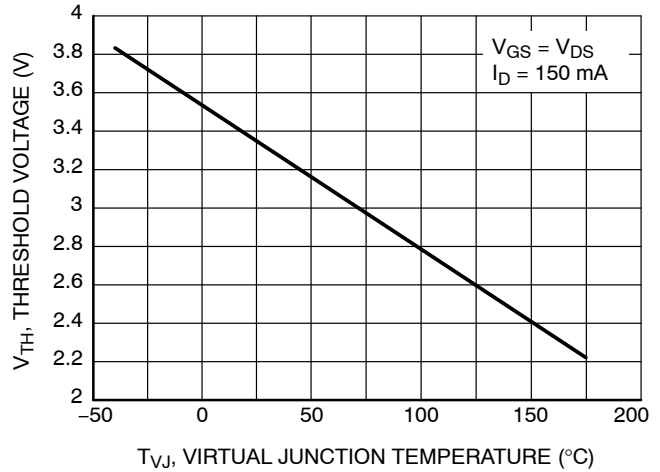

Figure 9. Gate Threshold Voltage vs. Temperature

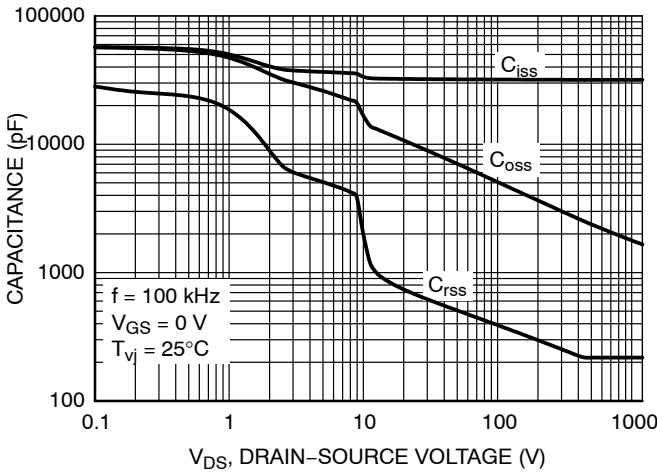

Figure 10. Typical Capacitance vs. Drain-Source Voltage

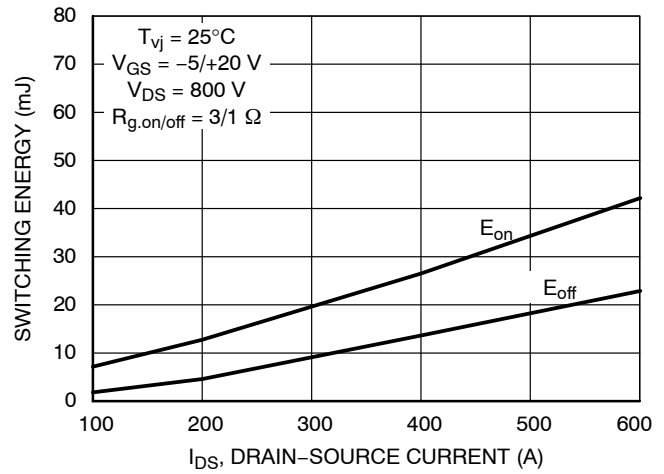

Figure 11. Switching Energies at 25°C

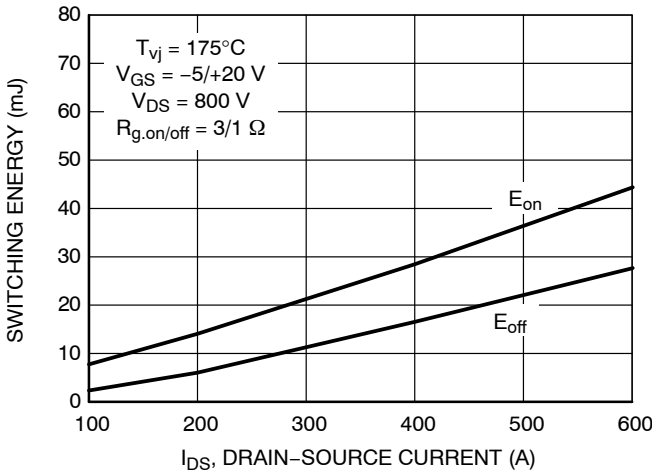

Figure 12. Switching Energies at 175°C

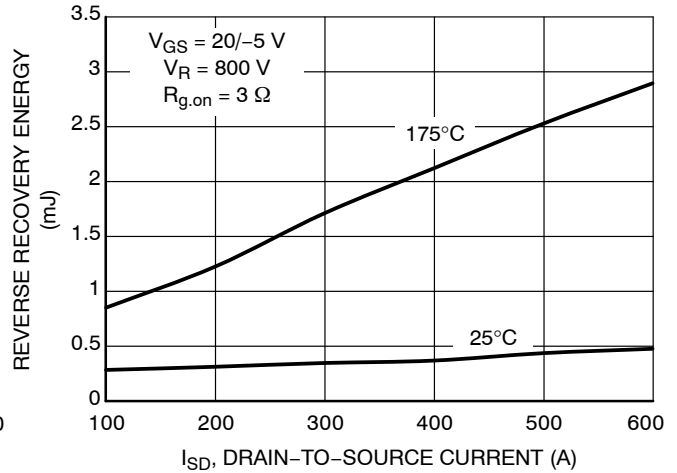

Figure 13. Reverse Recovery Energy vs. Drain-Source Current

TYPICAL CHARACTERISTICS

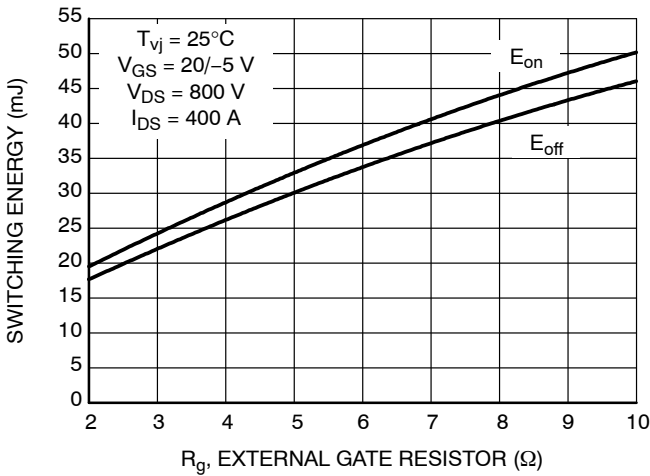

Figure 14. Switching Energies vs. External Gate Resistor

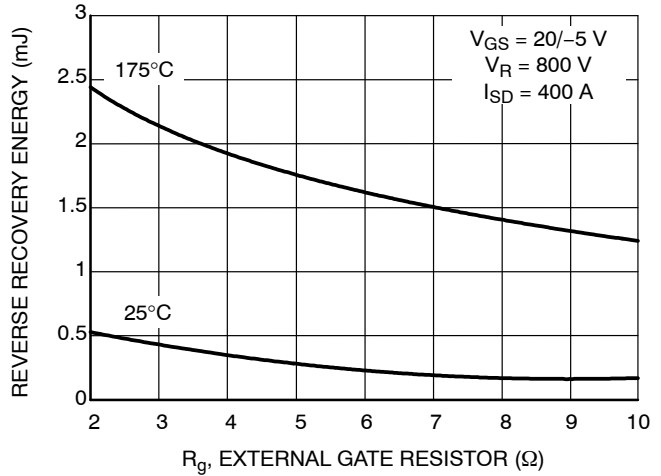

Figure 15. Reverse Recovery Energy vs. External Gate Resistor

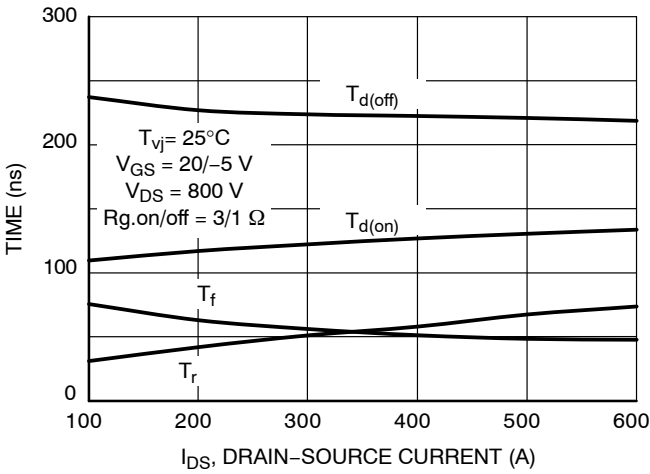

Figure 16. Timing Characteristics vs. Drain-Source Current

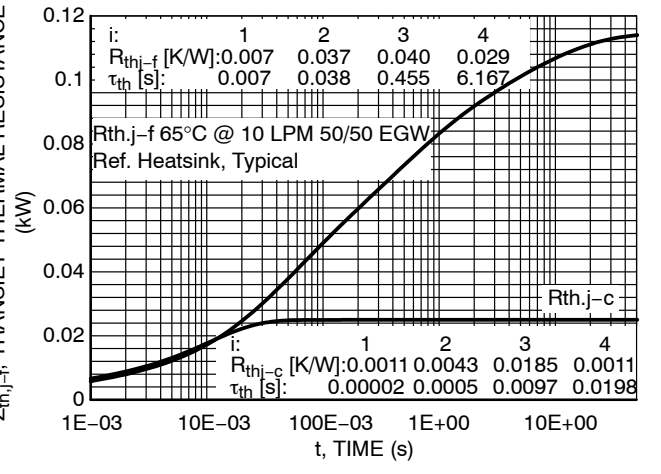

Figure 17. Typical Thermal Impedance

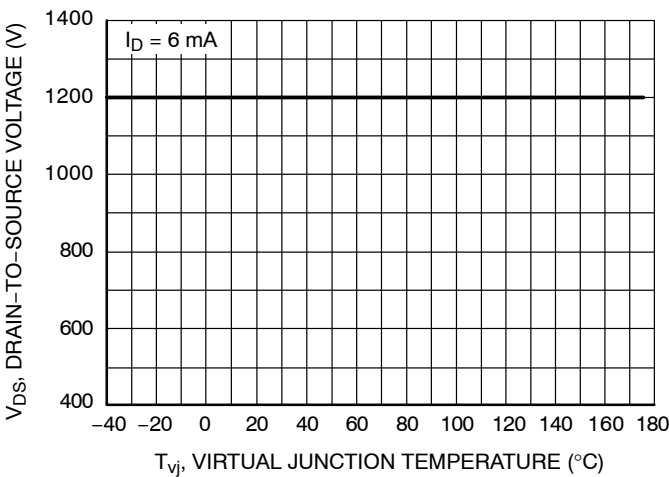

Figure 18. MOSFET Breakdown Voltage vs. T_{vj}

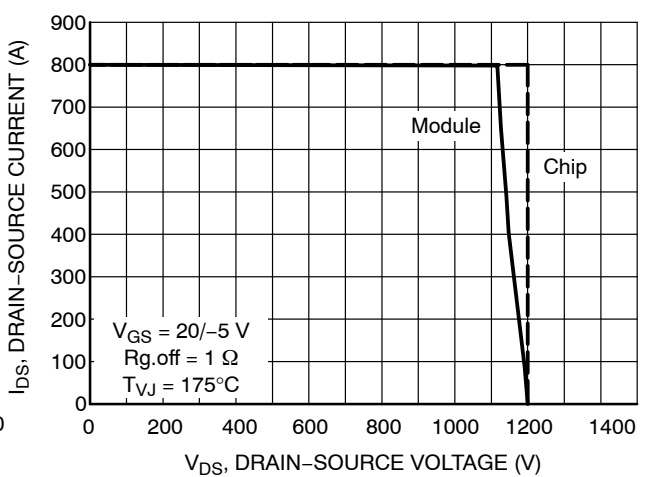

Figure 19. MOSFET RBSOA of Chip and Module

NVVR26A120M1WSS

TYPICAL CHARACTERISTICS

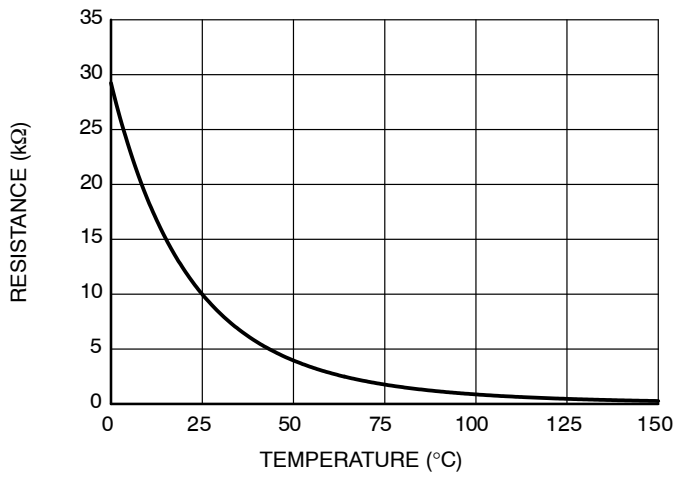

Figure 20. NTC Resistance vs. Temperature

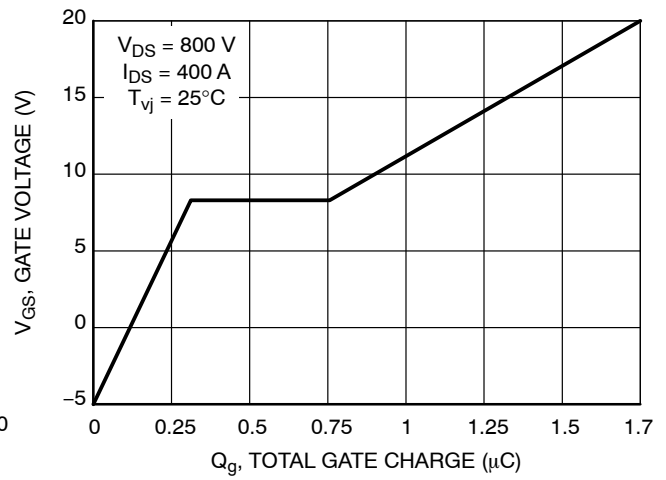
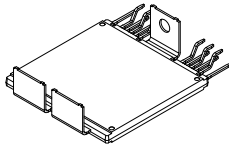

Figure 21. Gate Charge vs. Gate-Source



AHPM15-CDI AUTOMOTIVE MODULE
CASE MODHN
ISSUE B

DATE 20 DEC 2022

NOTES:

1. DIMENSIONING AND TOLERANCING PER ASME Y14.5M, 2009.
2. CONTROLLING DIMENSION: MILLIMETERS
3. DIMENSIONS D & E DO NOT INCLUDE MOLD PROTRUSIONS
4. DIMENSIONS b,b1,b2 DO NOT INCLUDE DAMBAR REMAIN.
5. MARKING AREA.
6. #1, 2 LEAD FINISH : NO PLATING
7. #3-#15 LEAD FINISH : Sn PLATING

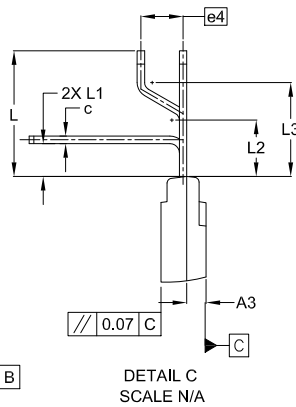
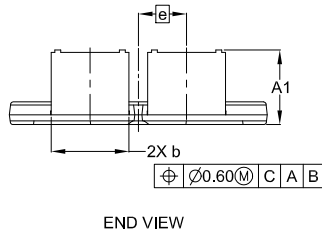
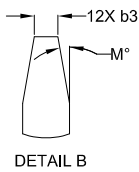
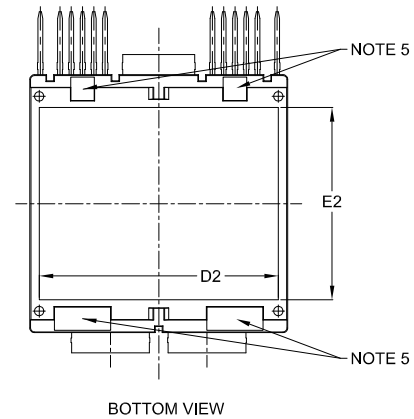
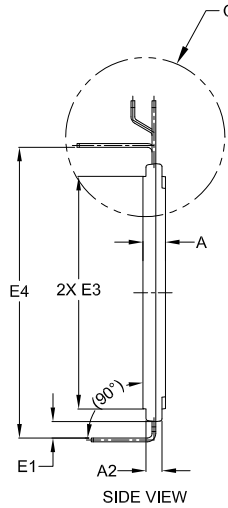
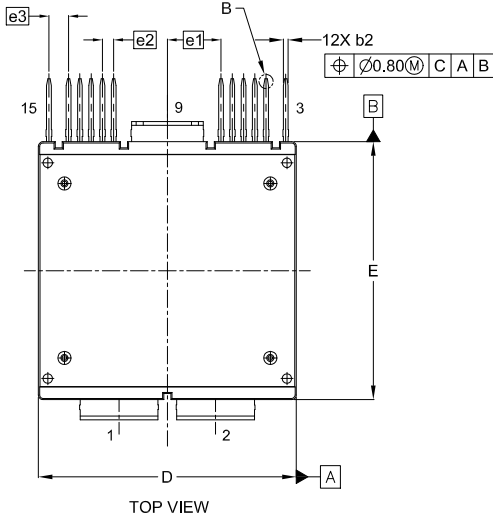
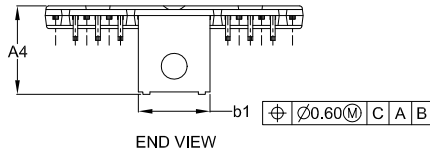

DIM	MILLIMETERS		
	MIN.	NOM.	MAX.
A	4.60	4.80	5.00
A1	15.55	15.85	16.15
A2	3.20	3.40	3.60
A3	1.70	2.05	2.40
A4	18.55	18.85	19.15
b	16.50	16.60	16.70
b1	15.20	15.30	15.40
b2	0.90	1.00	1.10
b3	0.50 REF		
c	0.70	0.80	0.90
D	54.80	55.00	55.20
D2	50.40	51.00	51.60

DIM	MILLIMETERS		
	MIN.	NOM.	MAX.
E	54.80	55.00	55.20
E1	3.25	3.50	3.75
E2	40.40	41.00	41.60
E3	49.40	49.60	49.80
E4	61.50	62.00	62.50
e	10.00	10.30	10.60
e1	11.15	11.45	11.75
e2	2.40 BSC		
e3	4.20 BSC		
e4	4.20	4.50	4.80
L	13.00	13.40	13.80
L1	3.10	3.50	3.90
L2	6.00 REF		
L3	10.00 REF		
M	10° REF		

DOCUMENT NUMBER:	98AON31392H	Electronic versions are uncontrolled except when accessed directly from the Document Repository. Printed versions are uncontrolled except when stamped "CONTROLLED COPY" in red.
DESCRIPTION:	AHPM15-CDI AUTOMOTIVE MODULE	PAGE 1 OF 2

onsemi and ONSEMI are trademarks of Semiconductor Components Industries, LLC dba onsemi or its subsidiaries in the United States and/or other countries. onsemi reserves the right to make changes without further notice to any products herein. onsemi makes no warranty, representation or guarantee regarding the suitability of its products for any particular purpose, nor does onsemi assume any liability arising out of the application or use of any product or circuit, and specifically disclaims any and all liability, including without limitation special, consequential or incidental damages. onsemi does not convey any license under its patent rights nor the rights of others.

AHPM15-CDI AUTOMOTIVE MODULE
CASE MODHN
ISSUE B

DATE 20 DEC 2022

**GENERIC
MARKING DIAGRAM***

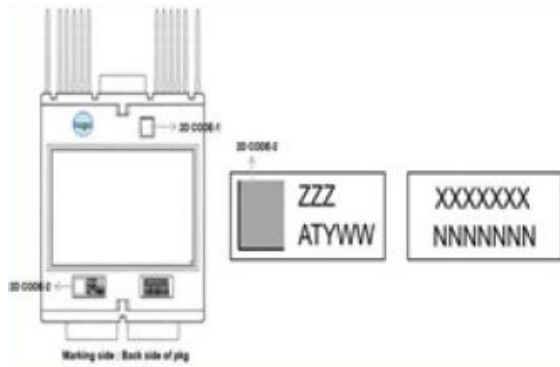

ZZZ = Assembly Lot Code
AT = Assembly & Test Location
Y = Year
WW = Work Week
XXXX = Specific Device Code
NNNN = Serial Number

*This information is generic. Please refer to device data sheet for actual part marking. Pb-Free indicator, "G" or microdot "μ", may or may not be present. Some products may not follow the Generic Marking.

DOCUMENT NUMBER:	98AON31392H	Electronic versions are uncontrolled except when accessed directly from the Document Repository. Printed versions are uncontrolled except when stamped "CONTROLLED COPY" in red.
DESCRIPTION:	AHPM15-CDI AUTOMOTIVE MODULE	PAGE 2 OF 2

onsemi and **ONSEMI** are trademarks of Semiconductor Components Industries, LLC dba **onsemi** or its subsidiaries in the United States and/or other countries. **onsemi** reserves the right to make changes without further notice to any products herein. **onsemi** makes no warranty, representation or guarantee regarding the suitability of its products for any particular purpose, nor does **onsemi** assume any liability arising out of the application or use of any product or circuit, and specifically disclaims any and all liability, including without limitation special, consequential or incidental damages. **onsemi** does not convey any license under its patent rights nor the rights of others.

onsemi, **Onsemi**, and other names, marks, and brands are registered and/or common law trademarks of Semiconductor Components Industries, LLC dba "**onsemi**" or its affiliates and/or subsidiaries in the United States and/or other countries. **onsemi** owns the rights to a number of patents, trademarks, copyrights, trade secrets, and other intellectual property. A listing of **onsemi**'s product/patent coverage may be accessed at www.onsemi.com/site/pdf/Patent-Marking.pdf. **onsemi** reserves the right to make changes at any time to any products or information herein, without notice. The information herein is provided "as-is" and **onsemi** makes no warranty, representation or guarantee regarding the accuracy of the information, product features, availability, functionality, or suitability of its products for any particular purpose, nor does **onsemi** assume any liability arising out of the application or use of any product or circuit, and specifically disclaims any and all liability, including without limitation special, consequential or incidental damages. Buyer is responsible for its products and applications using **onsemi** products, including compliance with all laws, regulations and safety requirements or standards, regardless of any support or applications information provided by **onsemi**. "Typical" parameters which may be provided in **onsemi** data sheets and/or specifications can and do vary in different applications and actual performance may vary over time. All operating parameters, including "Typicals" must be validated for each customer application by customer's technical experts. **onsemi** does not convey any license under any of its intellectual property rights nor the rights of others. **onsemi** products are not designed, intended, or authorized for use as a critical component in life support systems or any FDA Class 3 medical devices or medical devices with a same or similar classification in a foreign jurisdiction or any devices intended for implantation in the human body. Should Buyer purchase or use **onsemi** products for any such unintended or unauthorized application, Buyer shall indemnify and hold **onsemi** and its officers, employees, subsidiaries, affiliates, and distributors harmless against all claims, costs, damages, and expenses, and reasonable attorney fees arising out of, directly or indirectly, any claim of personal injury or death associated with such unintended or unauthorized use, even if such claim alleges that **onsemi** was negligent regarding the design or manufacture of the part. **onsemi** is an Equal Opportunity/Affirmative Action Employer. This literature is subject to all applicable copyright laws and is not for resale in any manner.

ADDITIONAL INFORMATION

TECHNICAL PUBLICATIONS:

Technical Library: www.onsemi.com/design/resources/technical-documentation
onsemi Website: www.onsemi.com

ONLINE SUPPORT: www.onsemi.com/support

For additional information, please contact your local Sales Representative at www.onsemi.com/support/sales