

Pamphlet

## High performance chip resistor

- High precision chip resistors
- High temperature chip resistors
- Anti-sulfurated chip resistors
- Current sensing chip resistors
- Small & High power chip resistors
- High voltage & High accuracy chip resistors

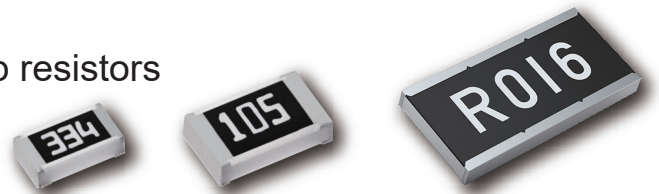

**IN Your  
Innovation**



# Safety and Legal Matters to Be Observed

## Product specifications and applications

- Please be advised that this product and product specifications are subject to change without notice for improvement purposes. Therefore, please request and confirm the latest delivery specifications that explain the specifications in detail before the final design, or purchase or use of the product, regardless of the application. In addition, do not use this product in any way that deviates from the contents of the company's delivery specifications.
- Unless otherwise specified in this catalog or the product specifications, this product is intended for use in general electronic equipment (AV products, home appliances, commercial equipment, office equipment, information and communication equipment, etc.). When this product is used for the following special cases, the specification document suited to each application shall be signed/sealed (with Panasonic Industry and the user) in advance. These include applications requiring special quality and reliability, wherein their failures or malfunctions may directly threaten human life or cause harm to the human body (e.g.: space/aircraft equipment, transportation/traffic equipment, combustion equipment, medical equipment, disaster prevention/crime prevention equipment, safety equipment, etc.).

## Safety design and product

- Please ensure safety through protection circuits, redundant circuits, etc., in the customer's system design so that a defect in our company's product will not endanger human life or cause other serious damage.
- This catalog shows the quality and performance of individual parts. The durability of parts varies depending on the usage environment and conditions. Therefore, please ensure to evaluate and confirm the state of each part after it has been mounted in your product in the actual operating environment before use. If you have any doubts about the safety of this product, then please notify us immediately, and be sure to conduct a technical review including the above protection circuits and redundant circuits at your company.

## Laws / Regulations / Intellectual property

- The transportation of dangerous goods as designated by UN numbers, UN classifications, etc., does not apply to this product. In addition, when exporting products, product specifications, and technical information described in this catalog, please comply with the laws and regulations of the countries to which the products are exported, especially those concerning security export control.
- Each model of this product complies with the RoHS Directive (Restriction of the use of hazardous substances in electrical and electronic equipment) (2011/65/EU and (EU) 2015/863). The date of compliance with the RoHS Directive and REACH Regulation varies depending on the product model. Further, if you are using product models in stock and are not sure whether or not they comply with the RoHS Directive or REACH Regulation, please contact us by selecting "Sales Inquiry" from the inquiry form.
- During the manufacturing process of this product and any of its components and materials to be used, Panasonic Industry does not intentionally use ozone-depleting substances stipulated in the Montreal Protocol and specific bromine-based flame retardants such as PBBs (Poly-Brominated Biphenyls) / PBDEs (Poly-Brominated Diphenyl Ethers). In addition, the materials used in this product are all listed as existing chemical substances based on the Act on the Regulation of Manufacture and Evaluation of Chemical Substances.
- With regard to the disposal of this product, please confirm the disposal method in each country and region where it is incorporated into your company's product and used.
- The technical information contained in this catalog is intended to show only typical operation and application circuit examples of this product. This catalog does not guarantee that such information does not infringe upon the intellectual property rights of Panasonic Industry or any third party, nor imply that the license of such rights has been granted.
- Design, materials, or process related to technical owned by Panasonic Industry are subject to change without notice.

## AEC-Q200 compliant

The products are tested based on all or part of the test conditions and methods defined in AEC-Q200. Please consult with Panasonic for the details of the product specification and specific evaluation test results, etc., and please review and approve Panasonic's product specification before ordering.

**Panasonic Industry will assume no liability whatsoever if the use of our company's products deviates from the contents of this catalog or does not comply with the precautions. Please be advised of these restrictions.**

# 91 years history of our company resistors

Our company has produced resistors for more than 91 years. Based on the concept, "Good products begin with Good components." by our founder Konosuke Matsushita, Panasonic started manufacturing fixed carbon film resistors for radio receivers in 1933 and reached the milestone of accumulative 2 trillion pieces production by 2013. By lining up with this number of resistors, standard 1608 mm size, we can make a round trip to the moon (244,198 miles).



**1966**

Established  
Fukui Matsushita  
Electric Company

**1933**

Started  
manufacturing  
resistors

**1974**

Completed  
Morita factory

**2003**

Reached total  
1 trillion pieces  
production

**2013**

Reached total  
2 trillion pieces  
production









**2018**

85<sup>th</sup> Anniversary  
of production

# INDEX

Our company chip resistors, product line-up			P4	
Characteristics of our company thick film chip resistors (Anti solder joint crack)			P5	
Proper Usage : Thick film & Thin film chip resistors			P6	
<b>High precision</b>	Thin film, High reliability type		ERA*A series P7	
	Thin film, High stability and reliability type		ERA*V/K series P8	
	High voltage & High accuracy type		ERA*P/ERJPM series P10	
	High precision thick film type		ERJPB series P12	
	Application		P13	
<b>Environment resistant</b>	High temperature type		ERJH series P14	
	Anti-sulfurated type	Normal	: ERJS/U series	P15
		High precision	: ERJU*R series	
Small & high power		: ERJC/ERJUP series		
Low resistance		: ERJU*S/Q series		
Array		: EXBU series		
Wide terminal	: ERJC series			
Anti-sulfurated series line-up		P16		
<b>Current sensing</b>	Low TCR high power / wide terminal type		ERJD series P17	
	Double-sided resistive element structure type		ERJ*BW series P18	
<b>Small &amp; High power</b>	Anti-surge type		ERJPA/P series P19	
	Wide terminal type		ERJB series P20	
Down sizing proposal			P21	
Main locations			P22	

[Description of the icon]

- |  |  |   |
|--|--|---|
|  : Reducing size what same power rating              |  : Reducing anti solder joint crack in heat cycle environment         |  : Reducing variation of resistance value under sulfur environment           |
|  : Improving durability for overloading              |  : Reaching higher power rating with same size                        |  : Reducing variation of resistance value under high temperature environment |
|  : Significantly reducing total resistance tolerance |  : Reducing variation of resistance value under temperature variation |  : Conforming AEC-Q200   |

[Applications]



# Our company chip resistors, product line-up

## High precision

**ERA\*A series**

**ERJPB series**

## High voltage

**ERA\*P series**

**ERJPM series**

## Environment resistant

**ERJU/ERJS series**

**EXBU series**

**ERJH series**

**ERA\*V/K series**

**ERJU\*R series**

**ERJUP series**

**ERJC series**

**ERJ\*BW series**

**ERJB series**

**ERJD series**

**ERJP series**

**ERJPA series**

## Current sensing

## Small & High power

**Thick film type**

**Thin film type**

# Characteristics of our company thick film chip resistors

## Anti solder joint crack

Reduces solder joint crack progression by originally developed soft terminal

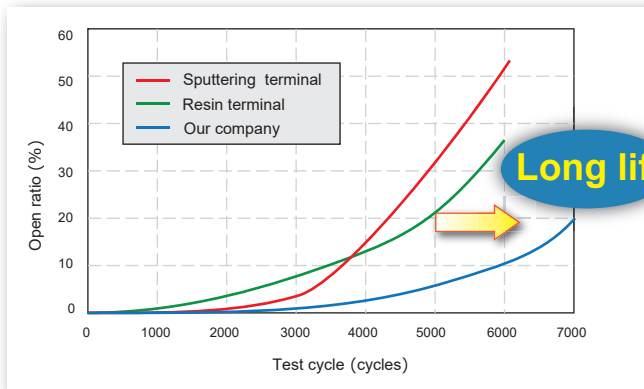

	Our company	Other company	
	Resin terminal (Soft terminal)	Resin terminal	Sputtering terminal
3000 cycle			
	No solder crack	Solder crack	

### Reduce solder joint crack

1. Long life for the set of device
2. Improvement of reliability



### Soft termination technology adopted

◆ Cooling and heating cycle lightens the stress ◆

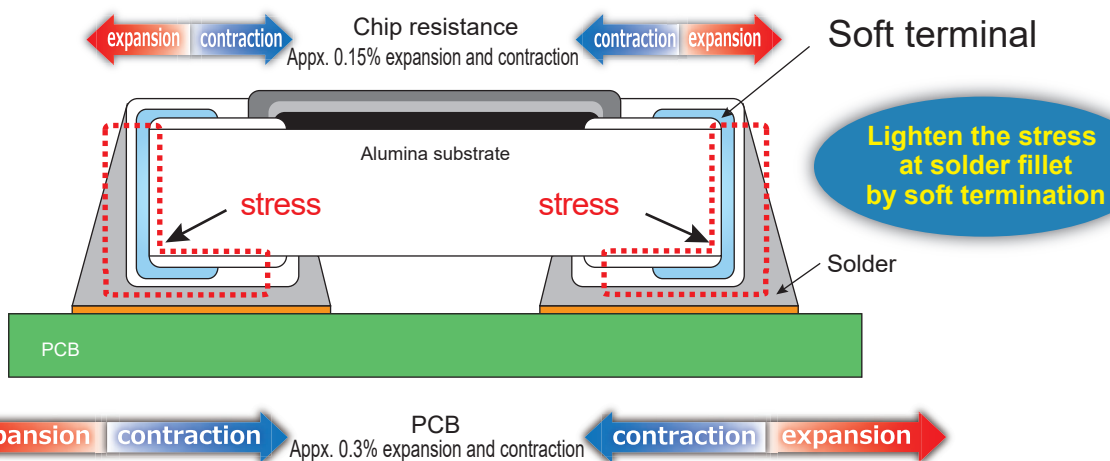

[ Maintain excellent solder connection reliability even in harsh temperature environment such as for automotive. ]

# Proper Usage: Thick film & Thin film chip resistors

## Tolerance · TCR Matrix

TCR (x10 <sup>-6</sup> /K) \ Tolerance (%)	10	15	25	50	100	100 <
0.05				Thick film chip area		
0.1	ERA*V/K	ERA*P				
			ERA*A			
0.5						
1	Thin film chip area					
5						

\*Our recommended combinations for Tolerance & TCR

## Chip resistors selection guide

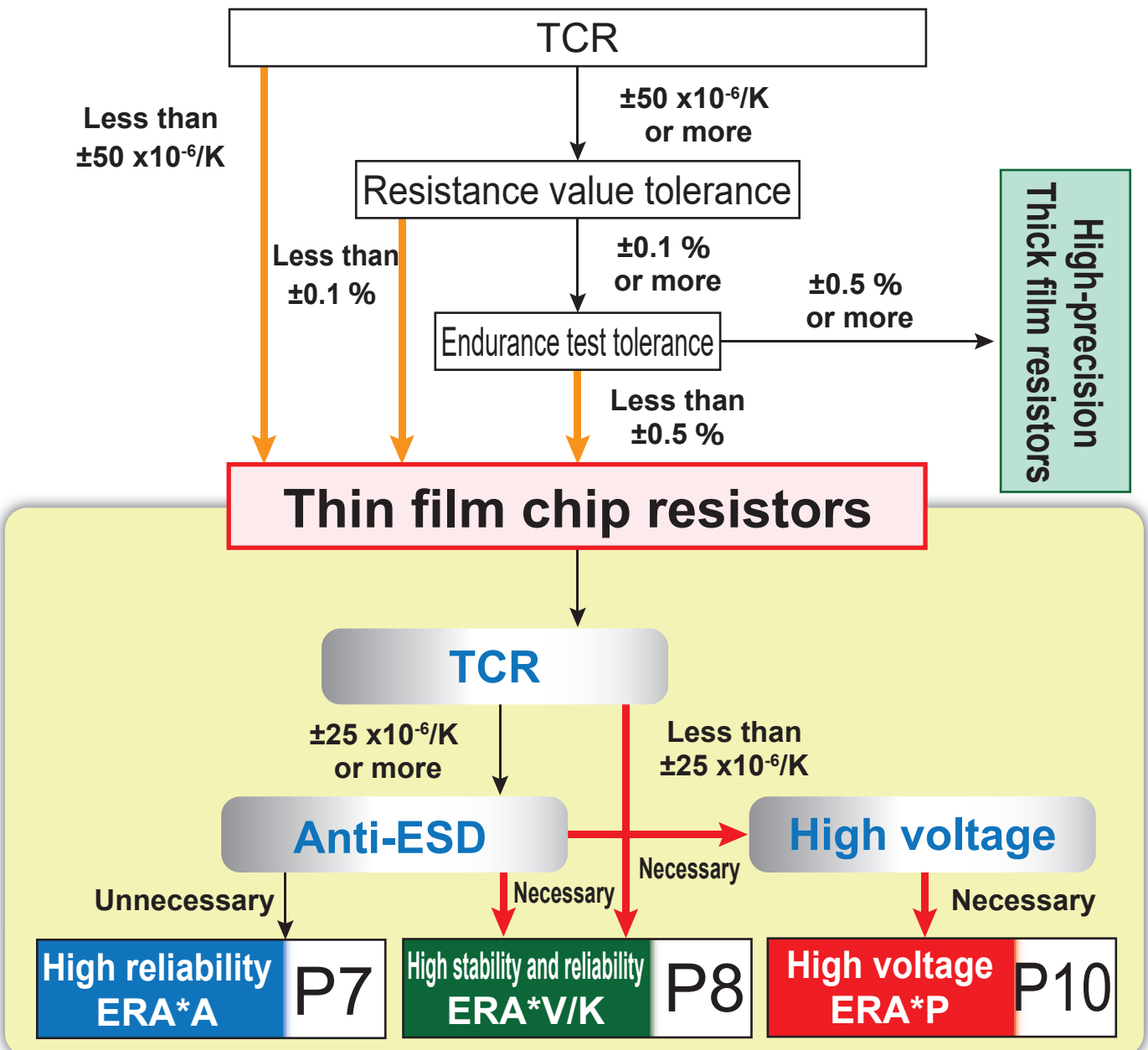

# High precision Thin film, High reliability type

High precision

Low TCR

Anti solder joint crack

AEC-Q200

## ERA\*A series

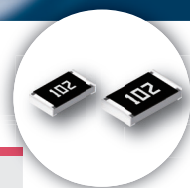

Reduce total resistance value by 1/4 from high-precision thick film resistors

- ✓ Resistance tolerance  $\pm 0.1\%$
- ✓ TCR  $\pm 25 \times 10^{-6}/K$
- ✓ Endurance test tolerance  $\pm 0.1\%$

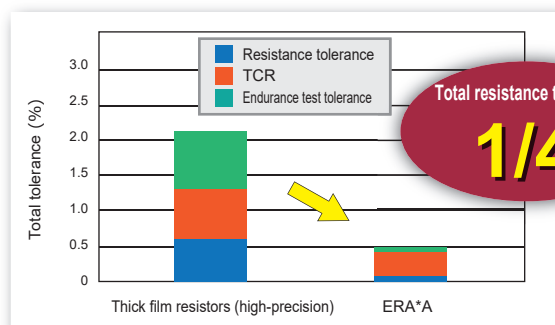

## Quarter total tolerance from high-precision thick film resistors

1. Suppress deterioration of set's performance and reliability in long-term use and temperature change
2. Save design cost by design margin securing



**Achieving high-stability (Endurance test tolerance less than 0.1%) with the unique based material**

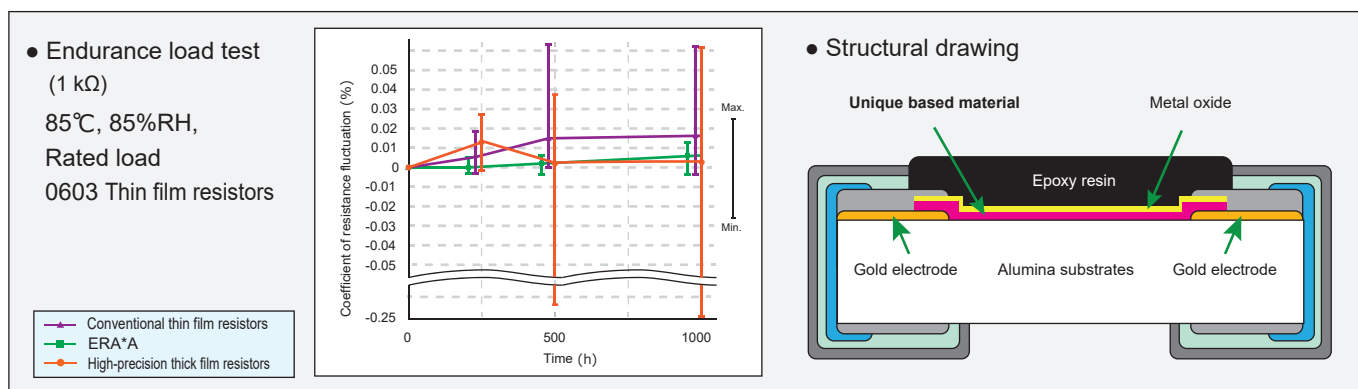

### Specifications

Part No.	Size (inch)	Power rating (W)	Limiting element voltage (V)	Resistance tolerance (%)	Resistance range (Ω)	TCR ( $\times 10^{-6}/K$ )	Category temp. range (°C)
ERA1AEB	0201	0.05	25	$\pm 0.1$	100 to 10 k	$\pm 25$	-55 to +155
ERA2AEB	0402	0.063	50	$\pm 0.1$	47 to 100 k	$\pm 25$	
ERA3AEB	0603	0.1	75	$\pm 0.1$	47 to 330 k	$\pm 25$	
ERA6AEB	0805	0.125	100	$\pm 0.1$	47 to 1 M	$\pm 25$	
ERA8AEB	1206	0.25	150	$\pm 0.1$	47 to 1 M	$\pm 25$	

Please visit our website for details !



# High precision

# Thin film, High stability and reliability type

High precision

Low TCR

Anti solder joint crack

Anti-Sulfurated

Anti-Surge

AEC-Q200

## ERA\*V/K series



Achieving higher-precision and longer-life than conventional\*1 series

- ✓ Resistance tolerance  $\pm 0.05\%$
- ✓ TCR  $\pm 10 \times 10^{-6}/K$
- ✓ Endurance test tolerance  $\pm 0.1\%$

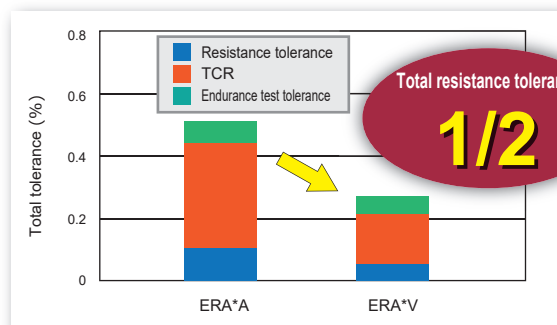

### Half total tolerance from thin film chip resistors (Conventional series)

1. High-precision, design margin securing and improve performance
2. Improve reliability in severe conditions

Point

Highest level of ESD resistance by preventing current concentration and reducing electric field strength

### Anti-ESD

- ESD test (1 k $\Omega$ )  
HBM : 150 pF, 2 kV,  $\pm 5$  times  
0603 Thin film chip resistors

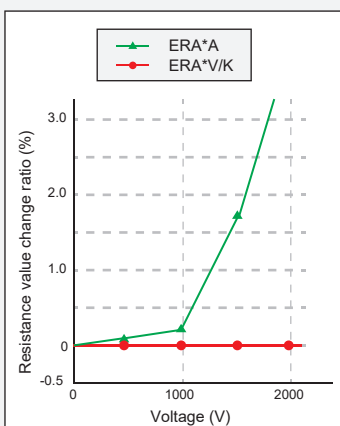

- Anti-ESD improved design

#### Resistor film thickness regularization

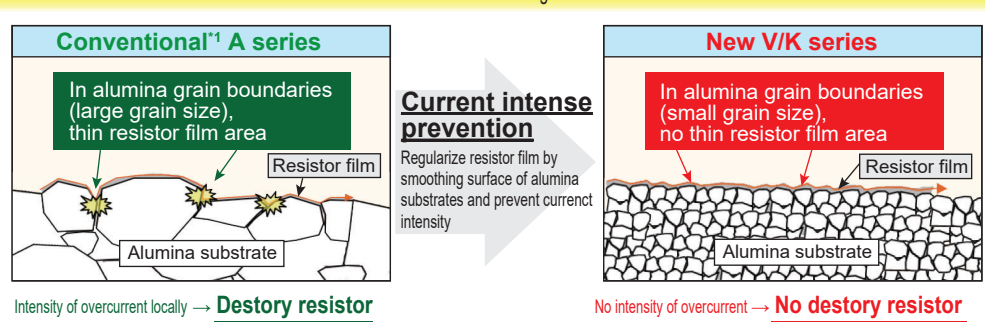

#### Expand resistor pattern length

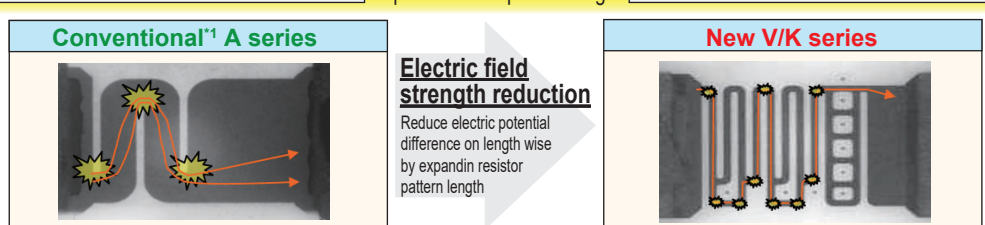

\*1: ERA\*A



## Improve anti-sulfurated by the introduction of edge sputtering electrode covering gap between protection film and electrode

### Anti-sulfurated

- Sulfurization gas test  
ASTM B809 : 105 °C 0603 Thin film chip resistors

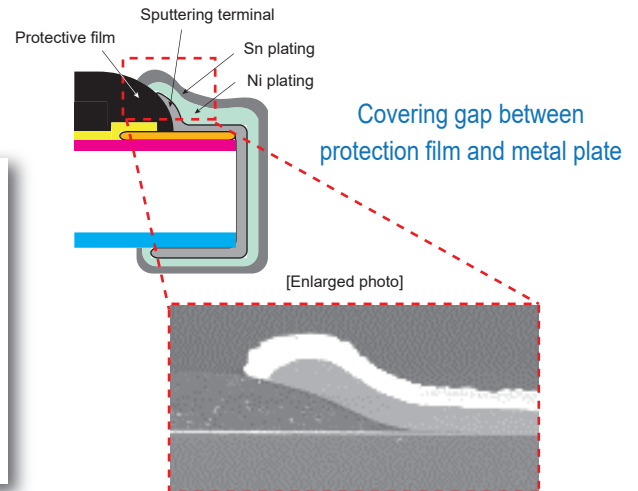
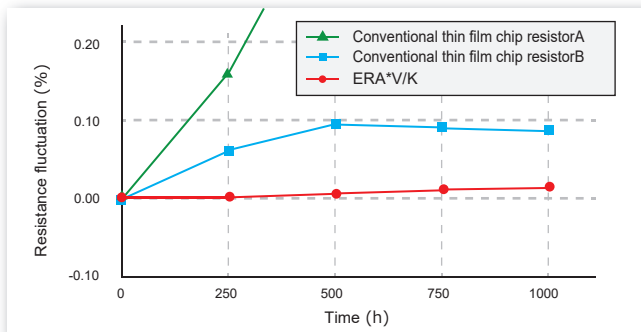

## Achieve excellent anti solder joint crack by back side resin layer

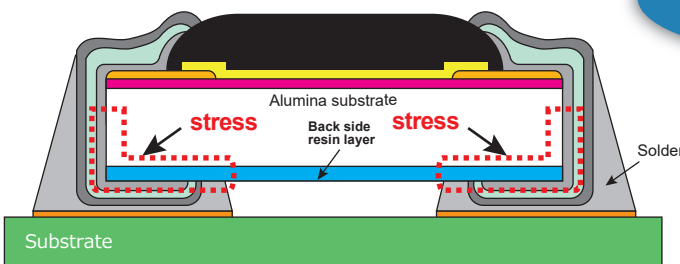
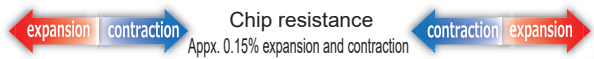

Lighten the stress at solder fillet by back side resin layer



2500 cycle crack ratio

ERA*V/K	Conventional thin film chip resistors
50 %	100 %

### Specifications

Part No.	Size (inch)	Power rating (W)	Limiting element voltage (V)	Resistance tolerance (%)	Resistance range (Ω)	TCR (x10 <sup>-6</sup> /K)	ESD withstand voltage (kV)	Category temp. range (°C)
ERA2V	0402	0.100	75	± 0.1 ±0.05	1 k ≤ R ≤ 47 k <sup>1</sup> 47 ≤ R ≤ 100 k <sup>1</sup>	±10(R) ±15(P) ±25(E)	1.0	-55 to +155
ERA3V ERA3K (100 kΩ over)	0603	0.125	100	± 0.1 ±0.05	1 k ≤ R ≤ 100 k 47 ≤ R ≤ 240 k	±10(R) ±15(P) ±25(E)	1.5	
ERA6V ERA6K (100 kΩ over)	0805	0.250	150	± 0.1 ±0.05	1 k ≤ R ≤ 100 k 47 ≤ R ≤ 750 k	±10(R) ±15(P) ±25(E)	2.0	
ERA8V ERA8K (100 kΩ over)	1206	0.250	200	± 0.1 ±0.05	1 k to 160 k 1 k to 1 M 47 to 1 M	±10(R) ±15(P) ±25(E)	2.0	

\*1: Expansion of resistance range

Please visit our website for details !



1206 size

High voltage · High accuracy type

- High precision
- Low TCR
- Anti solder joint crack
- Anti-Surge
- AEC-Q200

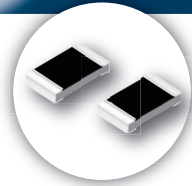

# ERA8P (Thin film) series

# ERJPM8 (Thick film) series

Reconciling the high limiting element voltage and the high precision.

- ✓ Limiting element voltage 500 V
- ✓ Resistance value accuracy Max. ± 0.1 %, ±15 x10<sup>-6</sup>/K
- ✓ Anti-solder crack design

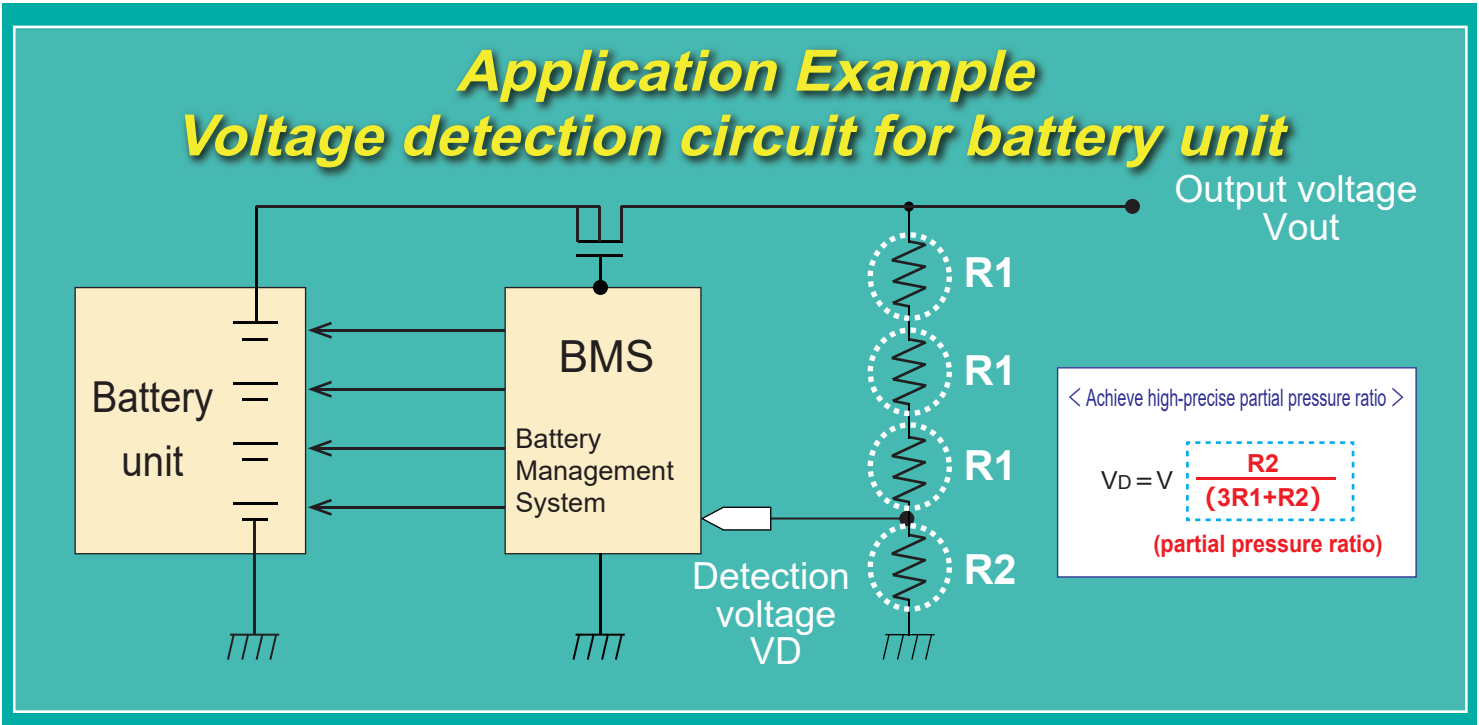

■ Specifications

Part No.	Size (inch)	Power rating (W)	Limiting element voltage (V)	Resistance tolerance (%)	Resistance range (Ω)	TCR (x10 <sup>-6</sup> /K)	Category temp. range (°C)
ERA8PPB	1206	0.25 (@85 °C)	500	± 0.1	160 k to 1 M (E24, E96)	± 15	-55 to +155
ERA8PEB						± 25	
ERJPM8F		0.66 (@70 °C)		± 1	1.02 M to 10 M (E24, E96)	± 100	

Please visit our website for details !



Proposal for the voltage sensing applications.

Current Other companies' products  
 0805 size  
 300 kΩ × 10 in-line

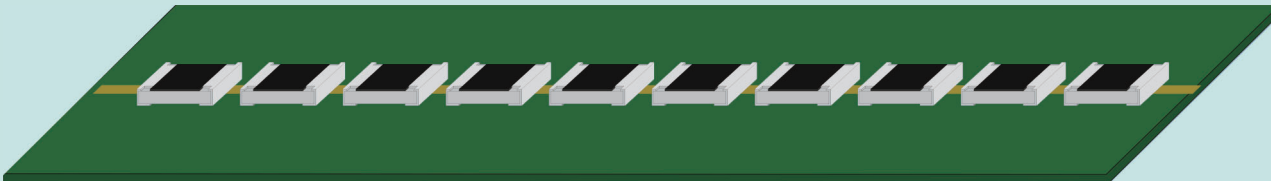

PCB sizing: 40.25 mm<sup>2</sup>

PCB down sizing  
**About 48% Reduction**

Suggestion A · B Our product  
 1206 size  
 1 MΩ × 3 in-line

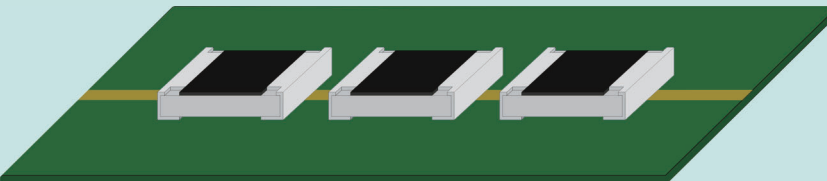

PCB sizing: 21.15 mm<sup>2</sup>

	Resistance value x usage	Resistance tolerance (%)	TCR (x10 <sup>-6</sup> /K)	Working voltage (V)	PCB sizing* (mm <sup>2</sup> )
Current : Other company 2012 Thin film resistance	300 kΩ x 10 in-line	± 0.1	± 25	150 x 10 p = 1500	21.15 (About 48% Reduction)
Suggestion A : <b>ERA8PEB</b> 1206 Thin film high resistance	1 MΩ x 3 in-line			500 x 3 p = 1500	
Suggestion B : <b>ERJPM8F</b> 1206 High resistance and high withstand voltage		± 1	± 100		

Our company unique computation.

# High precision High precision thick film type

High precision

Low TCR

Anti solder joint crack

AEC-Q200

## ERJPB series

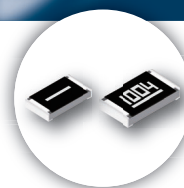

Same tolerance level as thin film

- ✓ Resistance tolerance  $\pm 0.1\%$
- ✓ TCR  $\pm 50 \times 10^{-6}/K$
- ✓ Endurance test tolerance  $\pm 0.5\%$

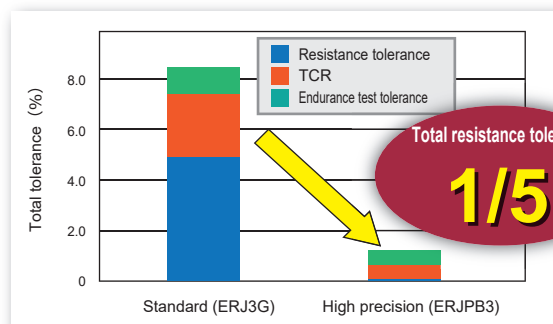

## Cut the total tolerance to 1/5

1. Design margin securing
2. Improvement of reliability
3. Cost saving for IC by reducing correction circuit

**Point** Achieved high precision resistance tolerance :  $\pm 0.1\%$  by unique resistive material and trimming

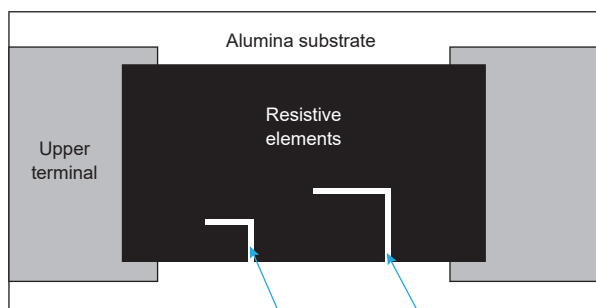

By unique "Double L-shaped trimming" process, we can make slight adjustments of resistance value.  
(2nd small L-shaped trimming has low adjustment rate)

### Specifications

Part No.	Size (inch)	Power rating (W)	Limiting element voltage (V)	Resistance tolerance (%)	Resistance range ( $\Omega$ )	TCR ( $\times 10^{-6}/K$ )	Category temp. range ( $^{\circ}C$ )
ERJPB3B	0603	0.20	150	$\pm 0.1, \pm 0.5$	200 to 100 k	$\pm 50$	-55 to +155
ERJPB6B	0805	0.25	150	$\pm 0.1, \pm 0.5$	200 to 1M	$\pm 50$	

Please visit our website for details !



# Application

## Application Example

### Current detection amplifier circuit for motor drive control unit

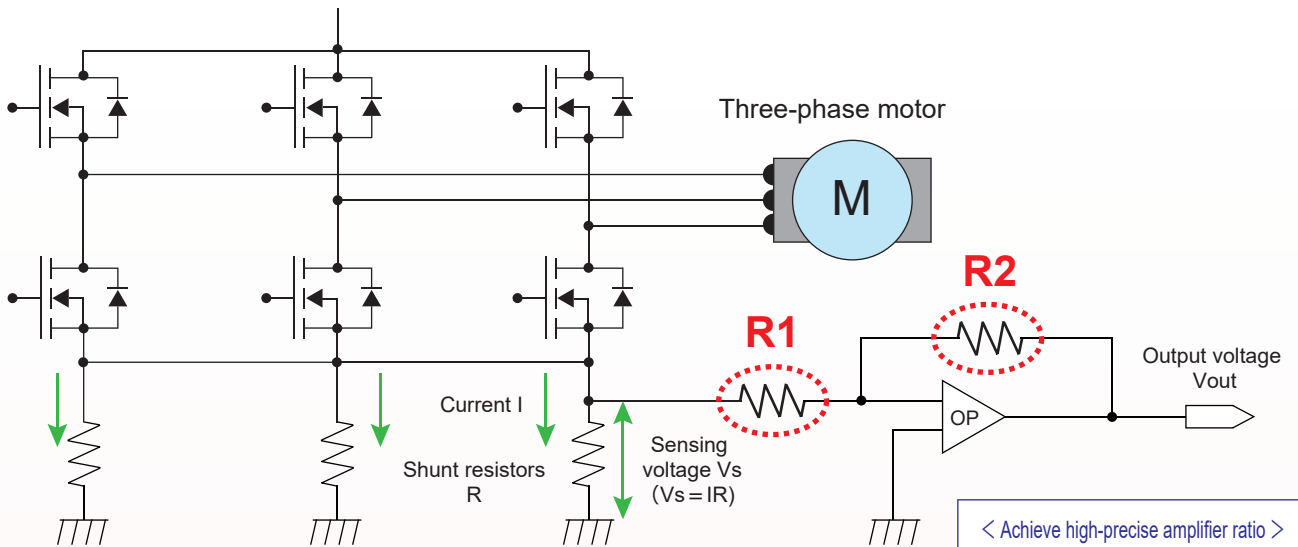

< Achieve high-precise amplifier ratio >

$$V_{out} = V_s \frac{R_2}{R_1}$$

(amplification rate)



Industrial robot

Automotive

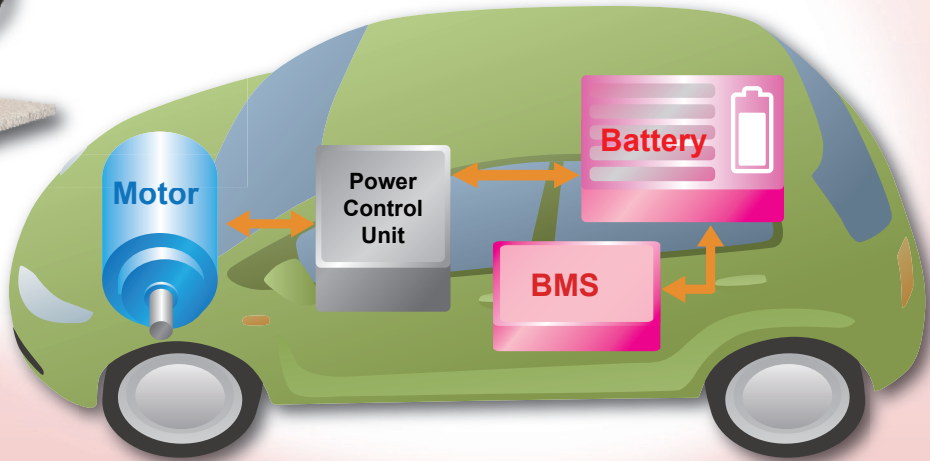

# Environment resistant High temperature chip resistor

Down  
sizing

High  
power

High  
temperature

Anti solder  
joint crack

AEC-  
Q200

## ERJH series

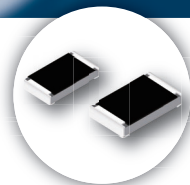

Achieves high heat resistance by new materials developing

Expansion of maximum operating temperature and rated operating temperature

(Example) 0603 size Load reduction curve

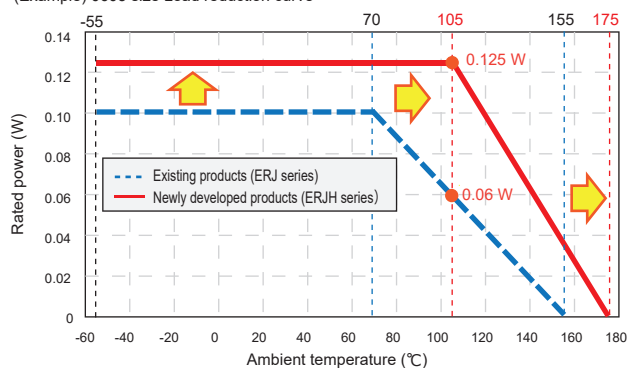

Extended solder life by suppressing crack progress

(Example) Test conditions : -55 °C / +175 °C 0603 size

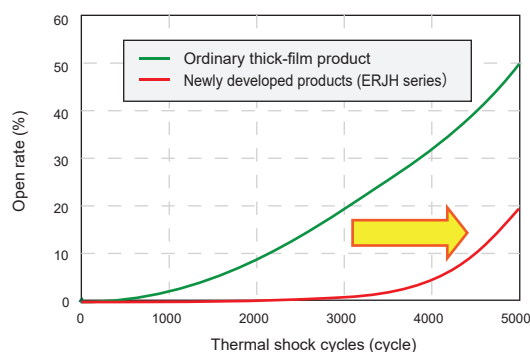

**Guarantees that the resistor endures 1000 cycles of thermal shock testing (-55°C/+175°C)**

1. Expand of max operating temperature 155 °C ⇒ 175 °C
2. Expand of rated operating temperature 70 °C ⇒ 105 °C
3. Improvement of solder crack resistance



**Excellent high heat resistance due to both material flexibility and heat resistance**

Overcome the trade-offs of conventional materials by reviewing the design of raw materials

✓ Improvement of operating temperature

✓ Suppression of solder cracks

Max operating temp. : 175 °C

Rated operating temp. : 105 °C

<material development concept>

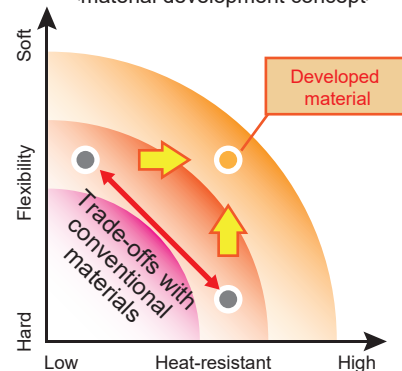

### ■ Specifications

Part No.	Size (inch)	Power rating (W)	Resistance tolerance (%)	Resistance range (Ω)	Category temp. range (°C)
ERJH2	0402	0.10	± 0.5, ± 1, ± 5	1 to 300 k	-55 to +175
ERJH3G/E	0603	0.125			
ERJH3Q		0.25		1 to 10	
ERJHP6	0805	0.50		1 to 300 k	

Please visit our website for details !



# Environment resistant Anti-Sulfurated series

Anti-Sulfurated

Anti solder joint crack

AEC-Q200

Standard : ERJS/U series    Low resistance : ERJU\*S/Q series  
 Array <sup>\*1</sup> : EXBU series    Small size & High power : ERJC/ERJUP series  
 High precision : ERJU\*R series    Wide terminal : ERJC series

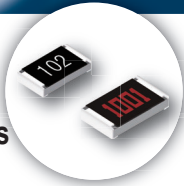

\*1 : AEC-Q200 Grade 1

**Anti-Sulfurated terminal reduces variation in the resistance value under harsh environment(sulfur)**

## ● Sulfurized oil immersion test of chip resistors

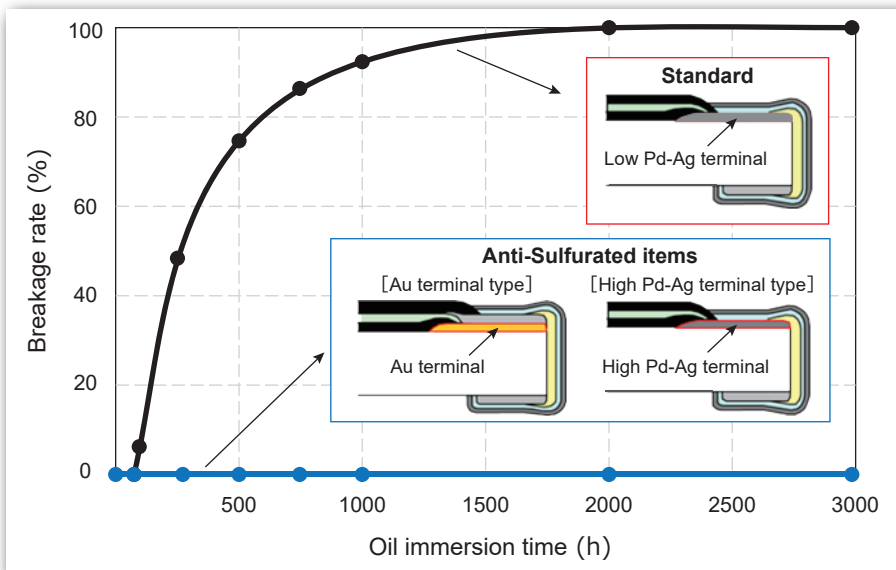

[Breakage in conventional items]

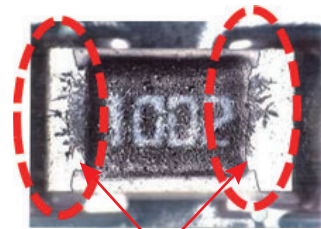

Sulfurated Ag needle crystal

[Non-Breakage in anti-sulfurated items]

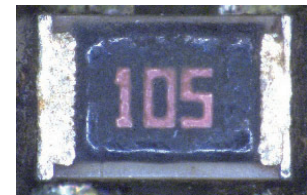

## ● Sulfurized oil immersion test of Au terminal and high Pd-Ag terminal

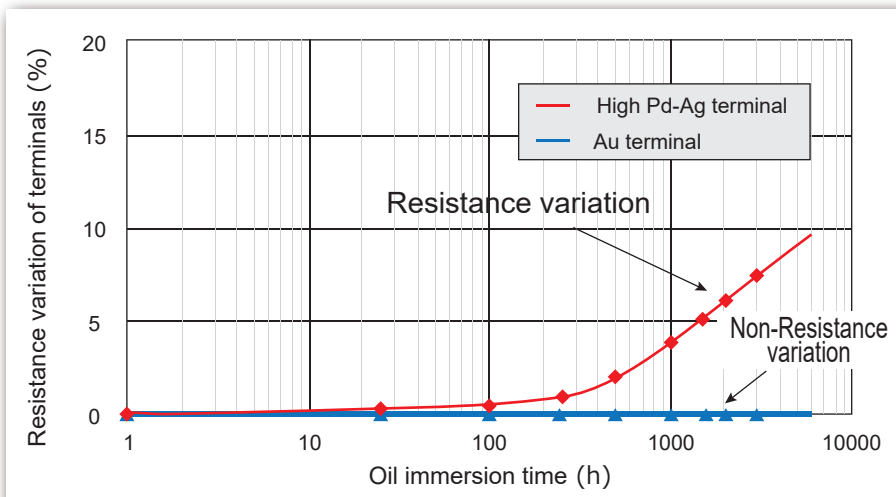

The sulfurization is inhibited with using Gold or Silver with high concentration Palladium as the inner electrode material. Each design have the high anti-sulfuration characteristics, but Gold type is much better.

**With Anti-Sulfurated characteristics,**

1. High reliability by reducing sulfurated breakage
2. Improve reliability of device at harsh environment
3. Cost reduction by unnecessary of sealing substrate

## Anti-Sulfurated series Line-up

< Wide lineup of Anti-Sulfurated chip resistors with anti-sulfurated electrode >

Size (inch)		01005	0201	0402	0603	0805	1206	1210	2010 1020 (Wide terminal)	2512	Web catalog
Standard				ERJS02	ERJS03	ERJS06	ERJS08	ERJS14	ERJS1D	ERJS1T	<a href="#">Click</a>
		ERJU0X	ERJU01	ERJU02	ERJU03	ERJU06	ERJU08	ERJU14	ERJU1D	ERJU1T	
Precision				ERJU2R	ERJU3R	ERJU6R					<a href="#">Click</a>
Small & High power					ERJUP3	ERJUP6	ERJUP8				<a href="#">Click</a>
Low resistance (0.1Ω to 1Ω)						ERJU6S					<a href="#">Click</a>
						ERJU6Q					
Wide terminal	Low resistance (10mΩ to 1Ω)								ERJC1B		<a href="#">Click</a>
									ERJC1C		
Array	2 resistors		EXBU14	EXBU24	EXBU34						<a href="#">Click</a>
	4 resistors		EXBU18	EXBU28	EXBU38						
	8 resistors			EXBU2H							

# Current sensing

## Low TCR high power / wide terminal type

Low  
TCR

Down  
sizing

High  
power

Anti solder  
joint crack

AEC-  
Q200

### ERJD series



**Achieved low-resistance / low-TCR  
~ VA proposal for metal shunt resistors ~**

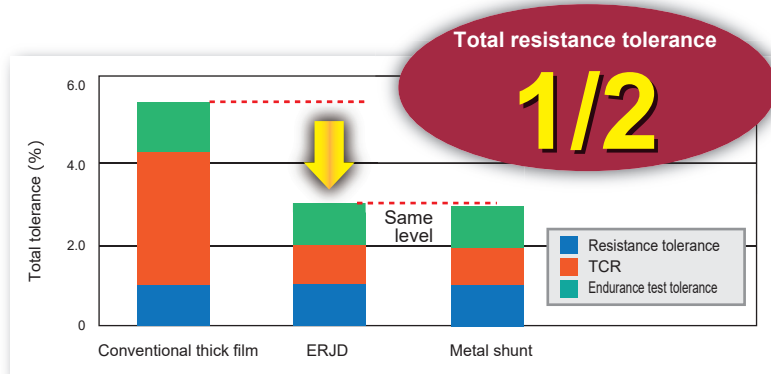

[ Reduces TCR of 10 mΩ from  $350 \times 10^{-6}/K$  to  $100 \times 10^{-6}/K$  ]

**Achieved same level performance as metal shunt resistor**

1. Design margin securing
2. Improvement of reliability
3. Cost saving

Point

**Achieved low resistance TCR by unique resistive material**

Reducing resistance value on the electrode

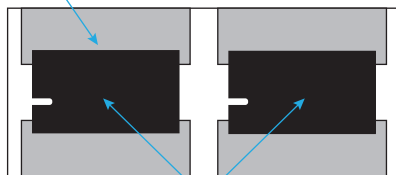

Unique based material

Resistive optimization material

- TCR is reduced with using Ag (Silver) / Pd (palladium) or Cu (Copper) / Ni (Nickel) as the resistive material.
- Achieved low TCR as same level as metal shunt resistors at more than 10 Ω.

#### ■ Specifications

Part No.	Size (inch)	Power rating (W)	Resistance tolerance (%)	Resistance range (Ω)	TCR (ppm/K)	Category temp. range (°C)
ERJD1	1020	2.0	± 1, ± 5	10 m to 200 m	± 100	-55 to 155
ERJD2	0612	1.0	± 1, ± 5	10 m to 200 m	± 100	

Please visit our website for details !

Click

# Current sensing

## Double-sided resistive elements structure type

High power

Down sizing

Anti solder joint crack

AEC-Q200

### ERJ\*BW series



Small case size, low resistance, and high power by double-sided resistive elements structure

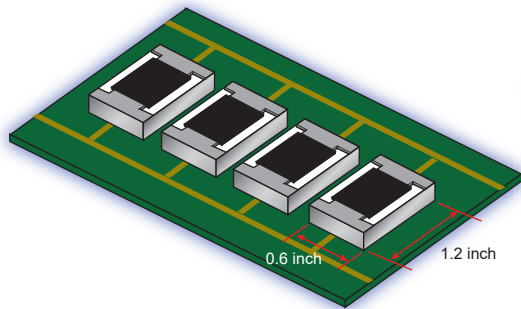

1206 size

PCB down sizing  
**45%**

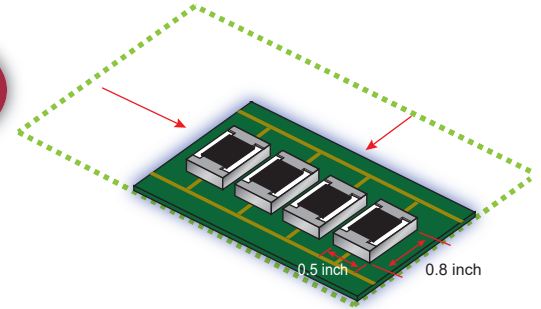
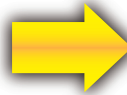

0805 size

[ Achieved smaller case size(1206 → 0805) than conventional type for 10 mΩ ]

### PCB area reduction

1. Down sizing
2. Weight saving
3. Cost saving

Point



Realized small current sensing resistors by double-sided resistive elements structure

#### Double-sided resistive elements structure

[ Side view ]

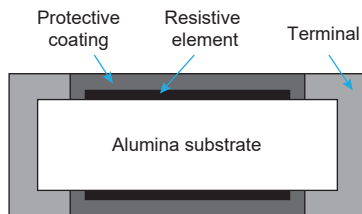

[ Top view ]

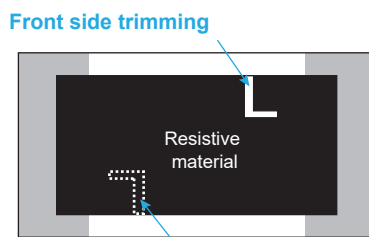

- Load concentration is reduced by two symmetrical L-shaped trimming,
- Achieved small size & high power and overload characteristics.

#### Specifications

Part No.	Size (inch)	Power rating (W)	Resistance tolerance (%)	Resistance range (Ω)	TCR (x10 <sup>-6</sup> /K)	Category temp. range (°C)
ERJ2BW	0402	0.25	± 1, ± 2, ± 5	47 m to 100 m	0 to +300	-55 to +155
ERJ3BW	0603	0.33	± 1, ± 2, ± 5	20 m to 100 m	20mΩ ≤ R < 39mΩ : 0 to +250 39mΩ ≤ R ≤ 100mΩ : 0 to +150	
ERJ6BW	0805	0.5	± 1, ± 2, ± 5	10 m to 100 m	10mΩ ≤ R < 15mΩ : 0 to +300 15mΩ ≤ R ≤ 100mΩ : 0 to +200	
ERJ8BW	1206	1.0	± 1, ± 2, ± 5	10 m to 100 m	10mΩ ≤ R < 20mΩ : 0 to +200 20mΩ ≤ R < 47mΩ : 0 to +150 47mΩ ≤ R ≤ 100mΩ : 0 to +100	

Please visit our website for details !



# Small size & High power Anti-Surge type

Down sizing

High power

Anti-Surge

Low TCR

Anti solder joint crack

AEC-Q200

## ERJPA/P0 series



### Improvement of High power & Anti-Surge rating

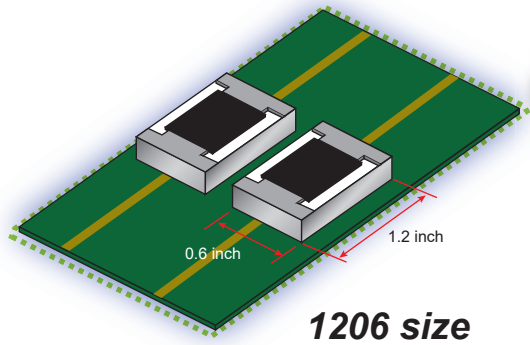

PCB down sizing  
**69%**

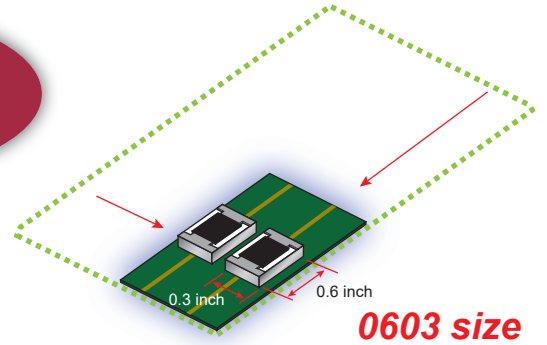

### PCB area reduction

1. Down sizing
2. Weight saving
3. Cost saving

### High Anti-Surge performance

1. Failure reduction
2. Design margin securing

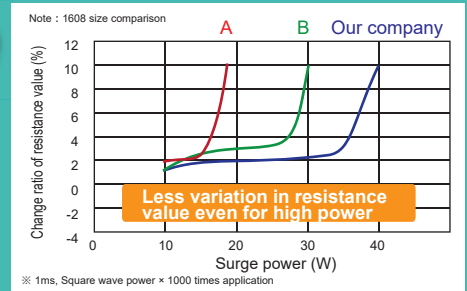

Point

### Surge distribution by unique resistive material / trimming

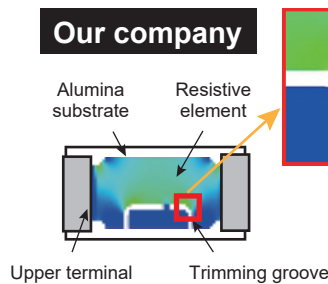
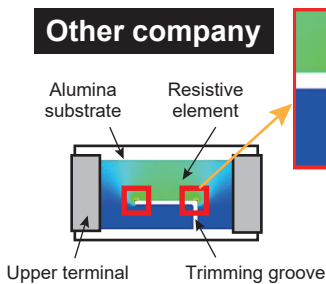

- Unique “Double-C shaped trimming” for surge distribution.
- Achieved small size & high power and overload characteristics.

#### Specifications

Part No.	Size (inch)	Power rating <sup>*1</sup> (W)	Rated terminal part temperature (°C)	Limiting element voltage (V)	Resistance tolerance (%)	Resistance range (Ω)	TCR <sup>*2</sup> (x10 <sup>-6</sup> /K)	Category temp. range (°C)
ERJPA2 <sup>*3</sup>	0402	0.25	100	50	± 0.5, ± 1	10 to 1 M (E24, E96)	± 100	-55 to +155
					± 5	10 to 1 M (E24)	± 200	
ERJPA3	0603	0.33	130	150	± 0.5, ± 1	10 to 1 M (E24, E96)	± 100	
					± 5	1 to 1.5 M (E24)	± 200	
ERJP06	0805	0.50	115	400	± 0.5, ± 1	10 to 1 M (E24, E96)	R < 33Ω : ± 300 33Ω ≤ R : ± 100	
					± 5	1 to 3.3 M (E24)	R < 10Ω : -100 to +600 10Ω ≤ R < 33Ω : ± 300 33Ω ≤ R : ± 200	

\*1 : The rated power is guaranteed with the terminal part temperature prescript.

\*2 : TCR is applied for the ± 1% product.

\*3 : AEC-Q200 Grade1

Please visit our website for details !



# Small size & High power Wide terminal type

Down sizing

High power

Anti-Surge

Low TCR

Anti solder joint crack

AEC-Q200

## ERJB series



### Improvement of High power & Anti-Surge rating

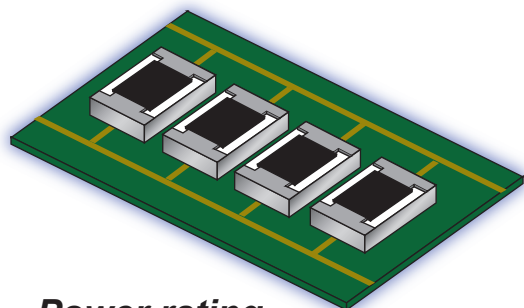

Power rating  
1 W products x 4p

Number of pieces  
**50%**

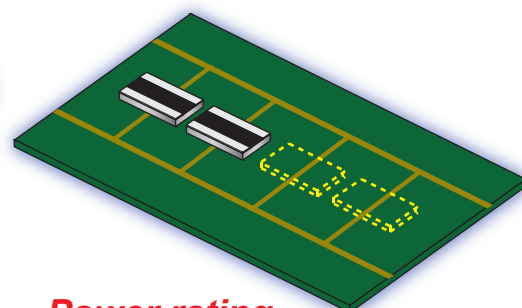

Power rating  
2 W products x 2p

#### Number of pieces reduction

1. Down sizing
2. Weight saving
3. Cost saving

#### High Anti-Surge performance

1. Failure reduction
2. Design margin securing

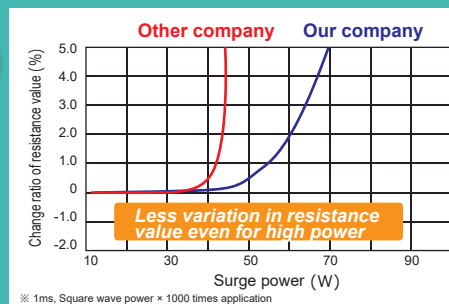

Point

### Higher power rating by wide termination structure with separated resistive elements

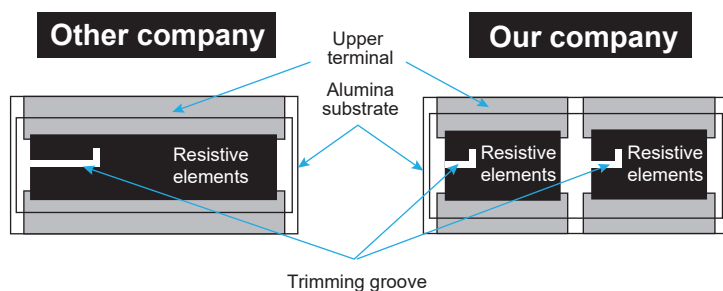

- Separated resistive elements for surge distribution.
- Achieved small size & high power and overload characteristics.

#### Specifications

Part No.	Size (inch)	Power rating <sup>*1</sup> (W)	Rated terminal part temperature (°C)	Limiting element voltage (V)	Resistance tolerance (%)	Resistance range (Ω)	TCR <sup>*2</sup> (x10 <sup>-6</sup> /K)	Category temp. range (°C)
ERJB1	1020	2.0 (R≤10)	125	200	± 1, ±2, ±5	10 m to 10 (E24)	10mΩ≤R<22mΩ : 0 to +350 22mΩ≤R<47mΩ : 0 to +200	-55 to +155
		1.0 (10<R)	95			11 to 10 k (E24)	47mΩ≤R<100mΩ : 0 to +150 100mΩ≤R≤10kΩ : ± 100	
ERJB2	0612	1.5 (R≤1 K)	125	200	± 1, ±2, ±5	10 m to 1 k (E24)	10mΩ≤R<22mΩ : 0 to +350 22mΩ≤R<47mΩ : 0 to +200	-55 to +155
		0.75 (1 K<R)	90			1.1 k to 1 M (E24)	47mΩ≤R<100mΩ : 0 to +150 100mΩ≤R<220mΩ : 0 to +100 220mΩ≤R≤10MΩ : ± 100	
ERJB3	0508	1.0	105	150	± 1, ±2, ±5	20 m to 10 (E24)	22mΩ≤R<47mΩ : 0 to +300 47mΩ≤R<1Ω : 0 to +200 1Ω≤R≤10Ω : ± 200	-55 to +155

\*1 : The rated power is guaranteed with the terminal part temperature prescript.









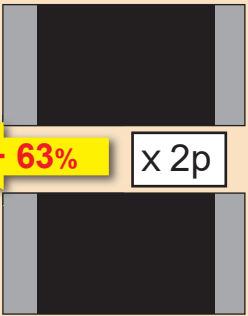

\*2 : TCR is applied for the ± 1% product.

Please visit our website for details !



# Down sizing proposal

Contributes to "PCB miniaturization" by replacing standard products with small & high-power products of the same or higher power rating.

Size (inch) Power (W)	0402	0603	0805	1206 0612 (Wide terminal)	3225	2010 1020 (Wide terminal)	2512
2.0						ERJB1 	 x 2p ← -63%
1.0				ERJB2 			 ← -65%
0.75							
0.5			ERJP06 				
0.25		ERJPA3 					
0.2	ERJPA2 						
0.125							

\* " ← " means down sizing rate (%) of PCB.

Our company

Standard

# Main locations

## ■ Japan bases

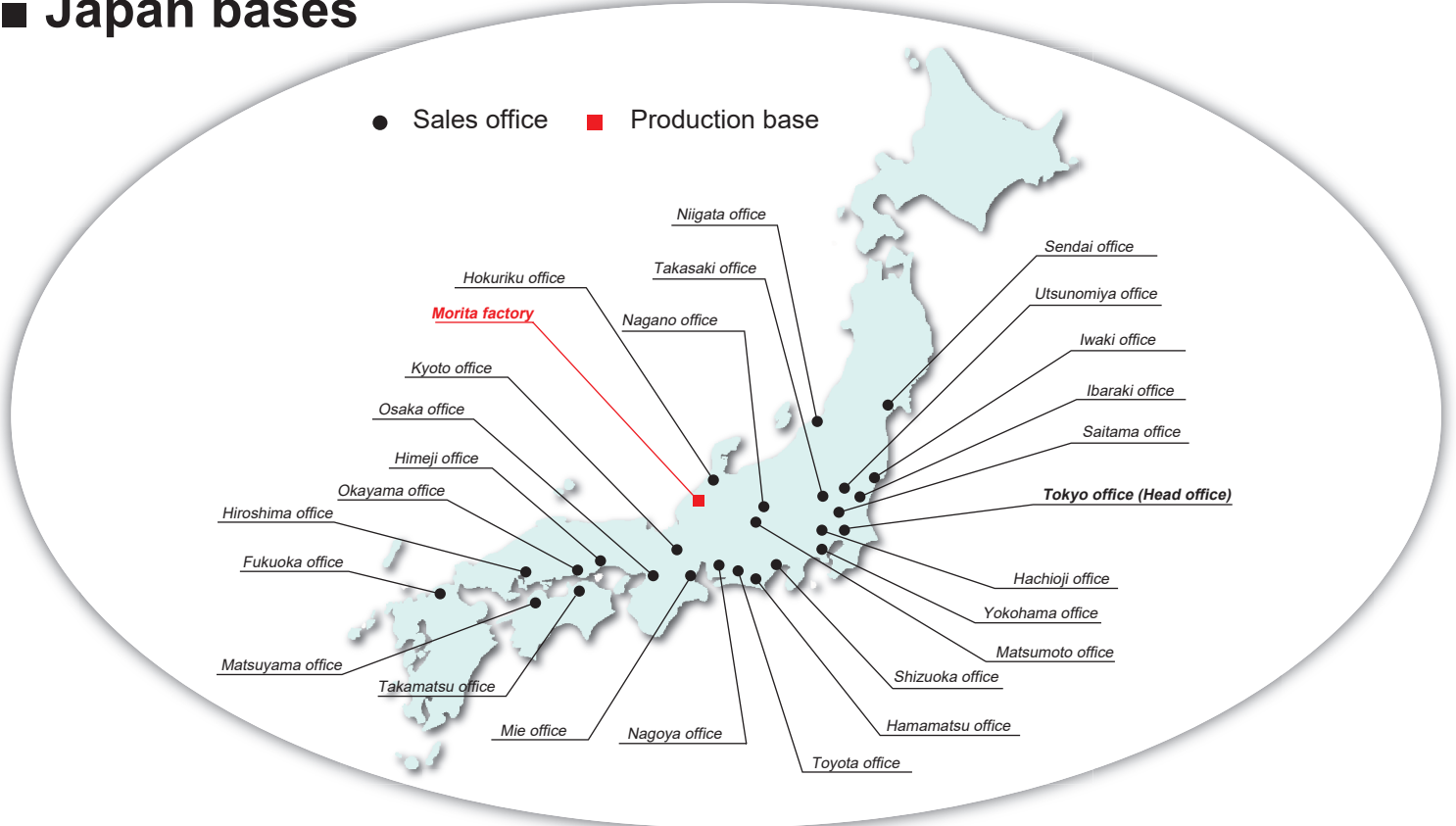

## ■ Overseas bases

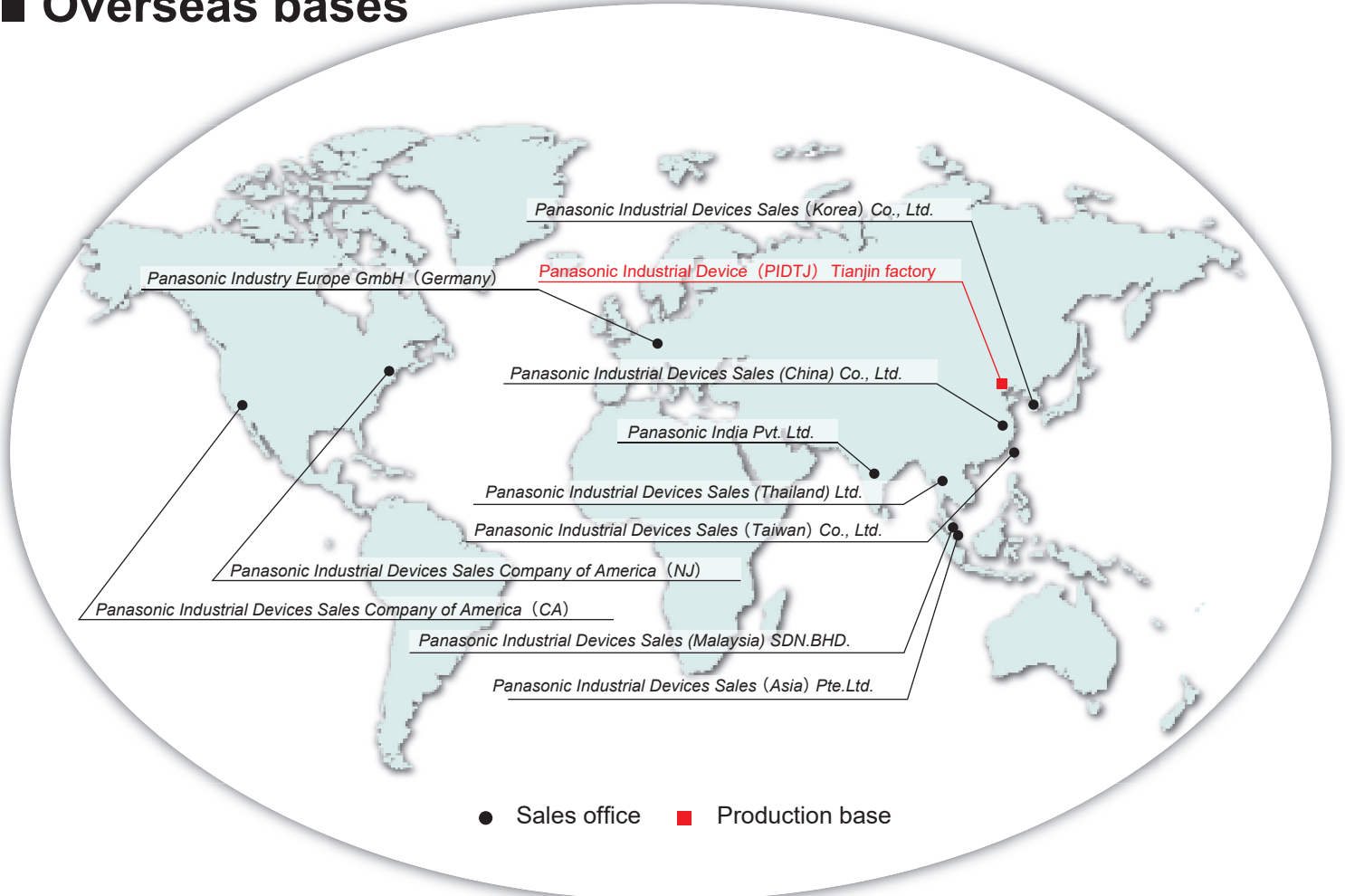

## Safety Precautions

When using our products, no matter what sort of equipment they might be used for, be sure to confirm the applications and environmental conditions with our specifications in advance.

**Panasonic**  
INDUSTRY

Thin / Thick film chip resistor

First edition : January 1, 2021

Revision : October 20, 2021

Revision : July 22, 2022

Revision : November 15, 2022

Revision : July 24, 2024

Panasonic Industry Co., Ltd.  
Device Solutions Business Division

1006 Kadoma, Kadoma City, Osaka

571-8506 Japan